

efka vario dc

CONTROL

DA82GA3312

with control panel V810/V820

LIST OF PARAMETERS

**CONNECTION DIAGRAM
TIMING DIAGRAMS**

No. 402276

English

CONTENTS	Page
1 Putting into Service	5
2 Socket Connectors	5
2.1 Position in the Control	5
2.2 Connection Diagram	6
3 Timing Diagrams	9
4 List of Parameters	20
4.1 Operator Level	20
4.2 Technician Level	21
4.3 Supplier Level	28
5 Error Displays	31
6 Slide-in Strips for the V810 Control Panel	32

1 Putting into Service

Before putting the control into service, the following must be ensured, checked and/or adjusted:

- The correct installation of the drive, position transmitter and accompanying devices, if necessary
- The correct adjustment of the direction of motor rotation using parameter 161
- The machine select, which can be verified using parameter 280
- If necessary, the setting of the reference position using parameter 170
- If necessary, the setting of the positions using parameter 171
- If necessary, the correct positioning speed using parameter 110
- If necessary, the correct maximum speed compatible with the sewing machine using parameter 111
- If necessary, the setting of the remaining relevant parameters
- Start sewing in order to save the set values

See instruction manual for details!

2 Socket Connectors

2.1 Position in the Control

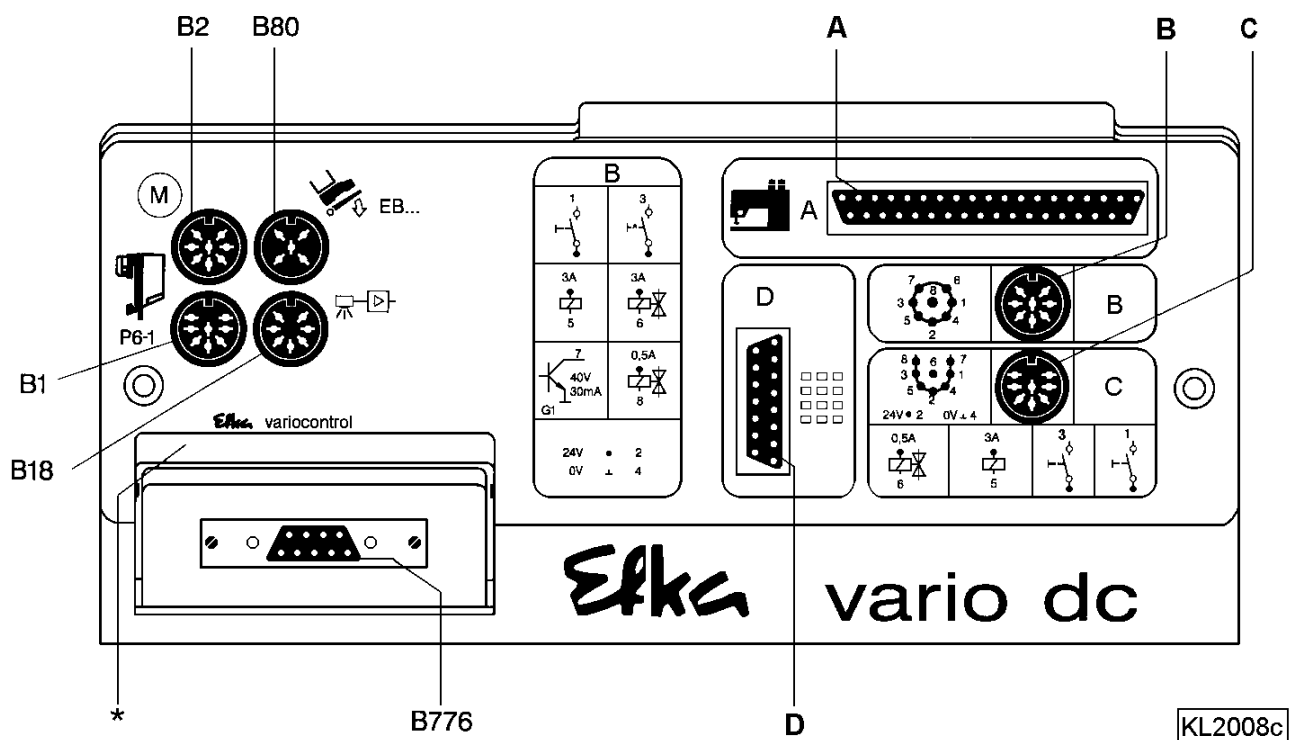

- B1** Position transmitter
- B2** Commutation transmitter for d.c. motor
- A (ST2)** Inputs and outputs
- B (B4)** Inputs and outputs
- C (B5)** Inputs and outputs
- D (B3)** Keys and light emitting diodes
- B18** Light barrier module / interface
- B80** Actuator
- B776** Control panel Variocontrol (as shown: 9/25-pin adapter plugged in)

*) **Type designation**

2.2 Connection Diagram

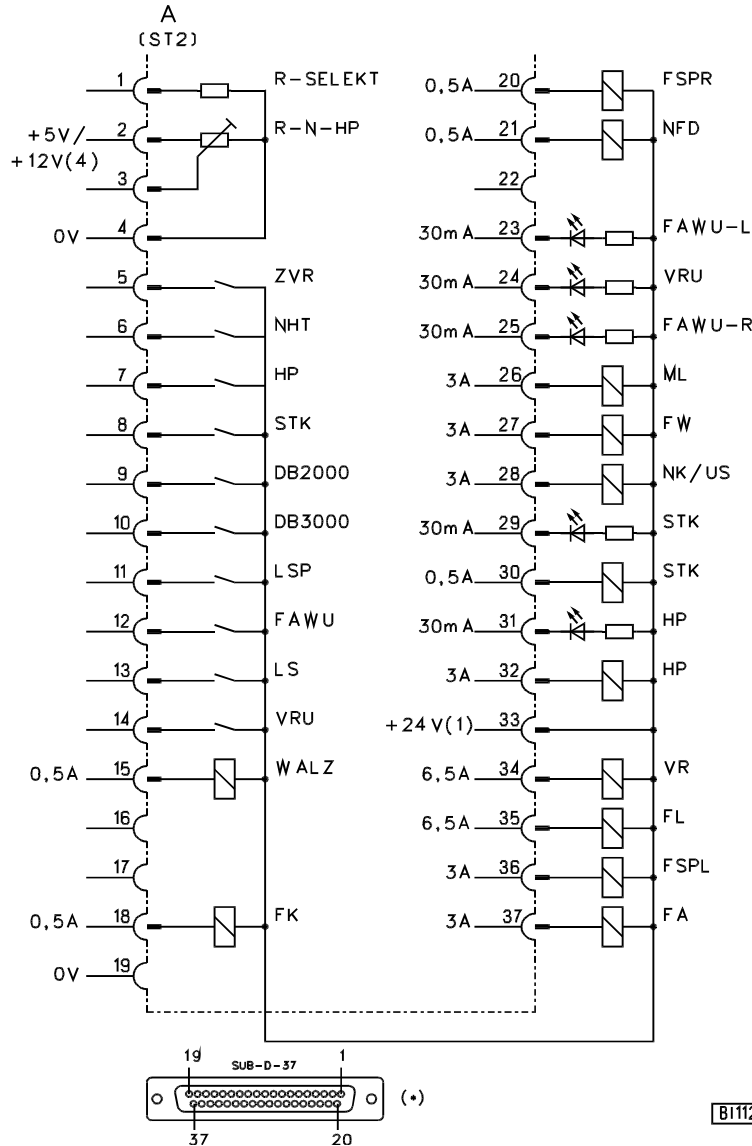

ATTENTION!
 When connecting the outputs, ensure that a total power of 96VA constant load will not be exceeded!

- | | | | |
|--------|-------------------------------|----------|--|
| DB2000 | - Speed limitation 2000 RPM | ML | - Motor running |
| DB3000 | - Speed limitation 3000 RPM | NFD | - Sewing foot pressure |
| FA | - Thread trimmer | NHT | - Needle up/down |
| FAWU-L | - Thread monitor bottom left | NK/US | - Needle cooling / option |
| FAWU-R | - Thread monitor bottom right | R-N-HP | - Setpoint potentiometer for speed limitation depending on high lift |
| FK | - Thread clamp | R-SELEKT | - Resistor for machine select |
| FL | - Sewing foot lift | STK | - Switch stitch length |
| FSPL | - Thread tension release | VR | - Backtacking |
| FSPR | - Thread tension reduction | VRU | - Backtack suppression / recall |
| FW | - Thread wiper | WALZ | - Roller feed |
| HP | - High lift limitation | ZVR | - Intermediate backtack |
| LS | - Light barrier | | |
| LSP | - Machine run blockage | | |

1) Nominal voltage +24V, no-load voltage max. 36V
 4) Nominal voltage +5V, 250 mA (can be switched to 12V, 250 mA after opening the cover)
 *) Front view of the socket (component side) and/or rear view of the plug (soldering side)

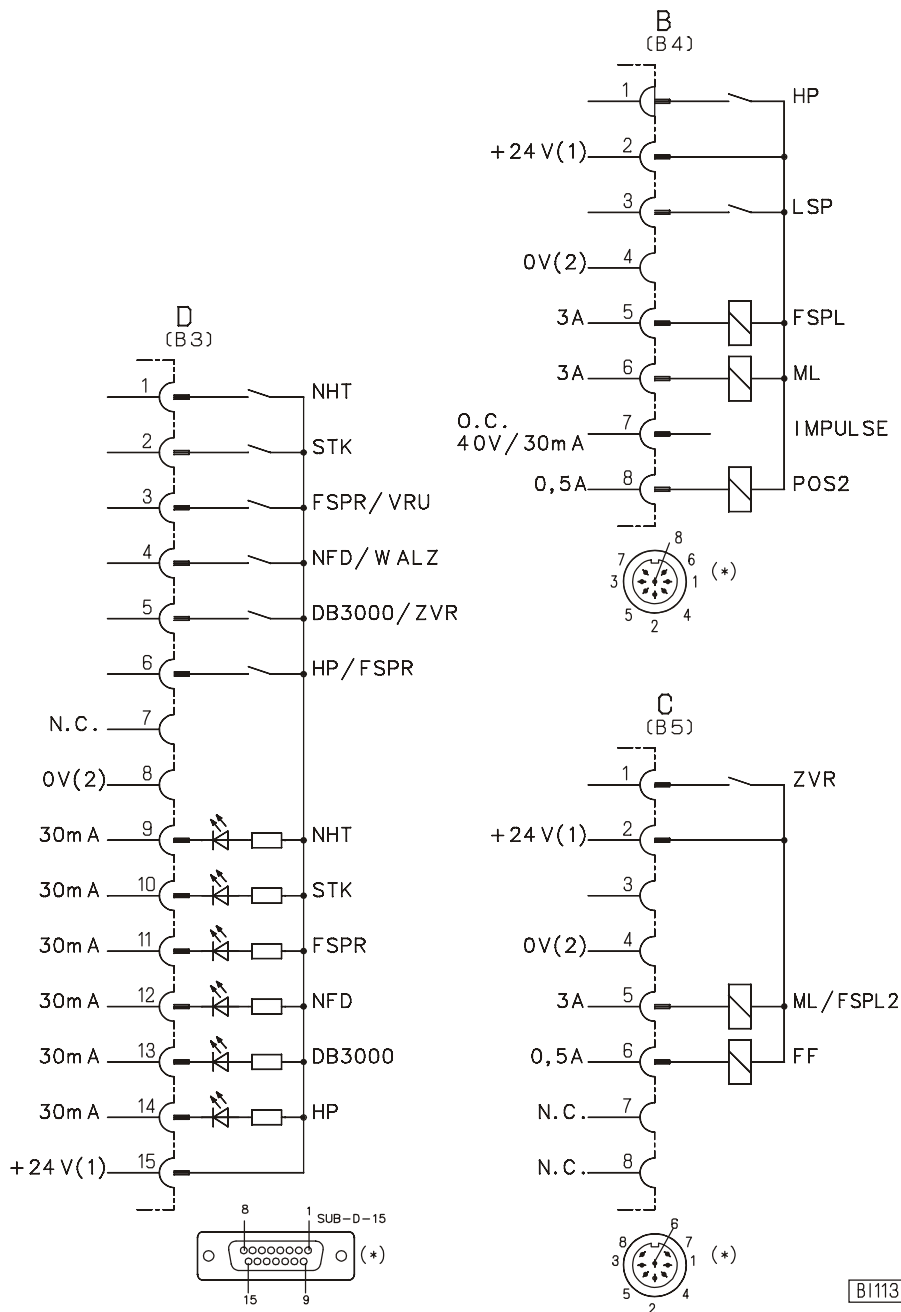
**ATTENTION!**

When connecting the outputs, ensure that a total power of 96VA constant load will not be exceeded!

DB3000	- Speed limitation 3000 RPM	ML/FSPL2	- Motor running/2nd thread tension release (selectable using parameter 198)
NHT	- Needle up/down	NFD	- Sewing foot pressure
FF	- Flip-flop	POS2	- Position 2
FSPL	- Thread tension release	STK	- Switch stitch length
FSPR	- Thread tension reduction	VR	- Backtacking
HP	- High lift limitation	VRU	- Backtack suppression / recall
IMPULSE	- Speedometer impulses (512/rotation)	WALZ	- Roller feed
LSP	- Machine run blockage	ZVR	- Intermediate backtack
ML	- Motor running		

1) Nominal voltage 24V, no-load voltage max. 36V

2) 0V connection of the load circuit

*) Front view of the socket (component side) and/or rear view of the plug (soldering side)

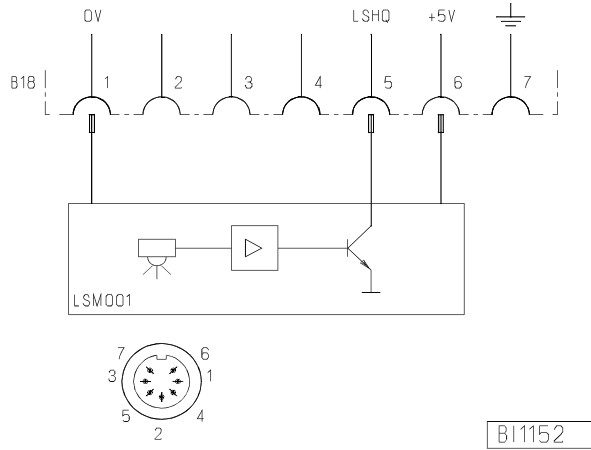

LSHQ
LSM001 or LSM001A

Light barrier command (identified when switched to 0V)
Light barrier module

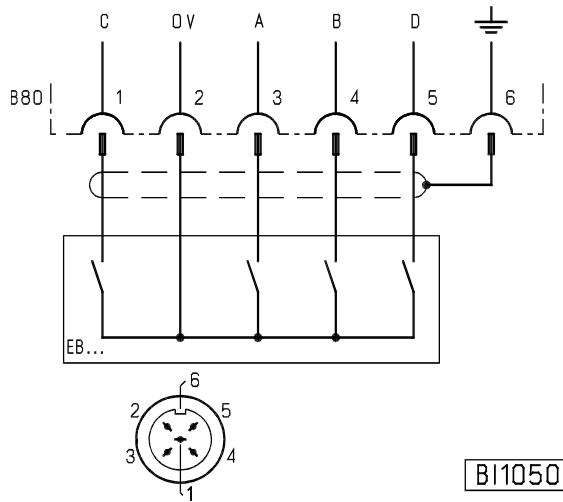

EB.. Actuator

Pedal step →	-2	-1	0	½	1	2	3	4	5	6	7	8	9	10	11	12
Input A	L	L	H	H	H	L	L	H	H	L	L	H	H	L	L	H
Input B	L	H	H	L	L	L	H	H	H	H	L	L	L	L	H	H
Input C	H	H	H	H	L	L	L	L	L	L	L	L	H	H	H	H
Input D	H	H	H	H	H	H	H	H	L	L	L	L	L	L	L	L

Switching supply voltage 5V or 12V

There is a supply voltage of +5V for external devices on the A/2 socket. After opening the cover, this voltage can be changed to +12V by replugging a multipole connector J1 on the printed circuit board.

- Open cover
- +5V = Connect lefthand pins 1 and 2 with jumper (factory setting)
- +12V = Connect righthand pins 3 and 4 with jumper
- Close cover

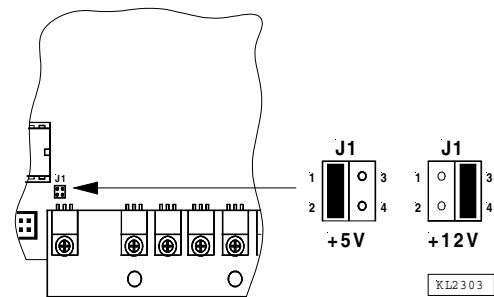

ATTENTION!
Before opening the control box, turn power off!

3 Timing Diagrams

Trimming from full machine run

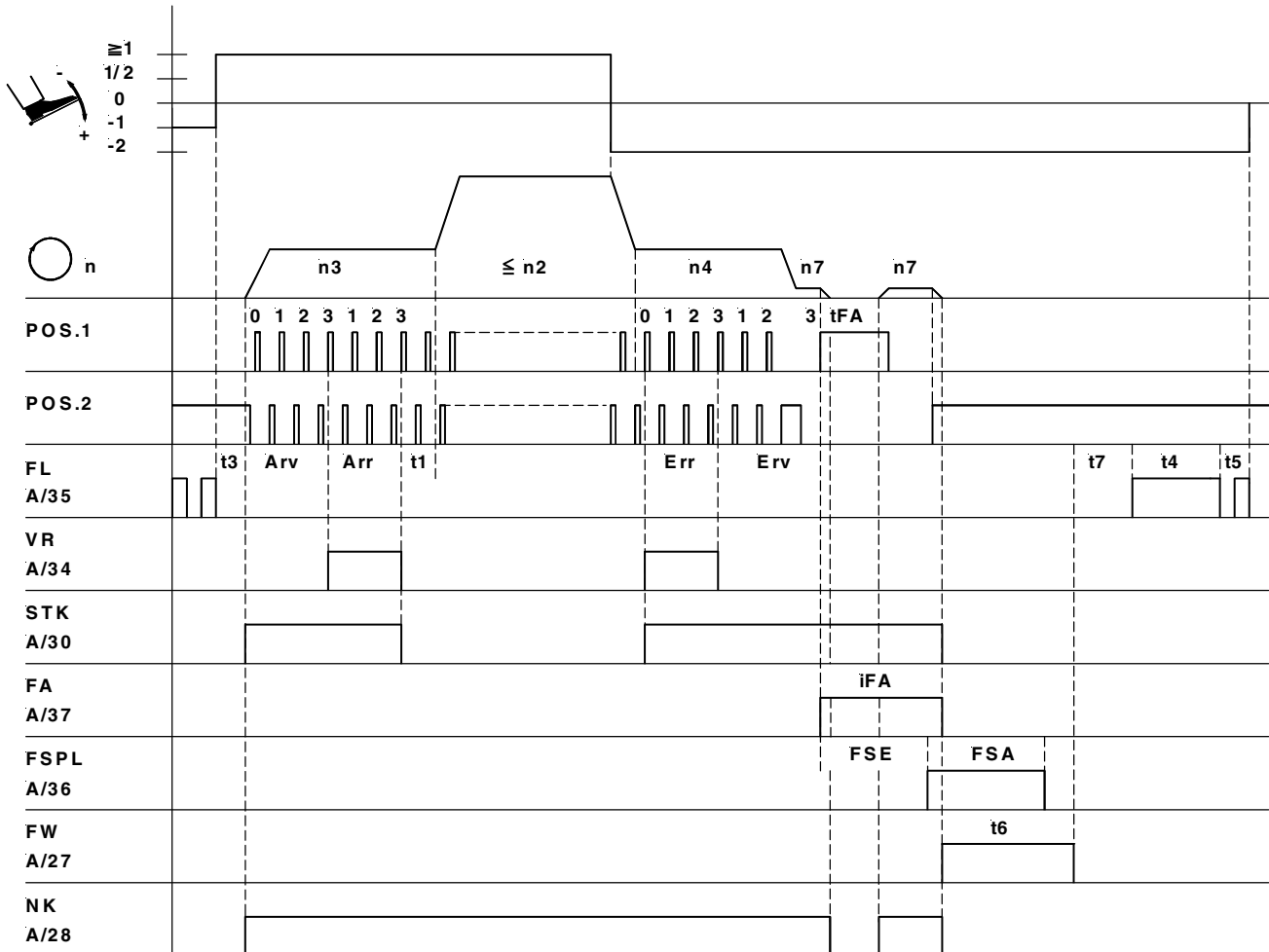

0214 / FALAU F

Mark	Function	Parameter	V810	V820
	Double start backtack	On	Key 1	Key 1
	Double end backtack	On	Key 2	Key 4
Slu	Long stitches during backtack	137 = ON		
n2	Maximum speed	111		
n3	Start backtack speed	112		
n4	End backtack speed	113		
n7	Trimming speed	116		
Arv	Start backtack stitches forward	000		
Arr	Start backtack stitches backward	001		
Err	End backtack stitches backward	002		
Erv	End backtack stitches forward	003		
iFA	Thread trimmer activation angle	190		
FSA	Thread tension release switch-off delay	191		
FSE	Thread tension release activation angle	192		
tFA	Stop time for thread trimmer in position 1	193		
t1	Delay until speed release after start backtack	200		
t3	Start delay from lifted sewing foot	202		
t4	Full power of sewing foot lifting	203		
t5	Holding power of sewing foot lifting	204		
t6	Thread wiper ON period	205		
t7	Sewing foot lifting delay time after thread wiping	206		

Backtacking with switch-on and switch off delay

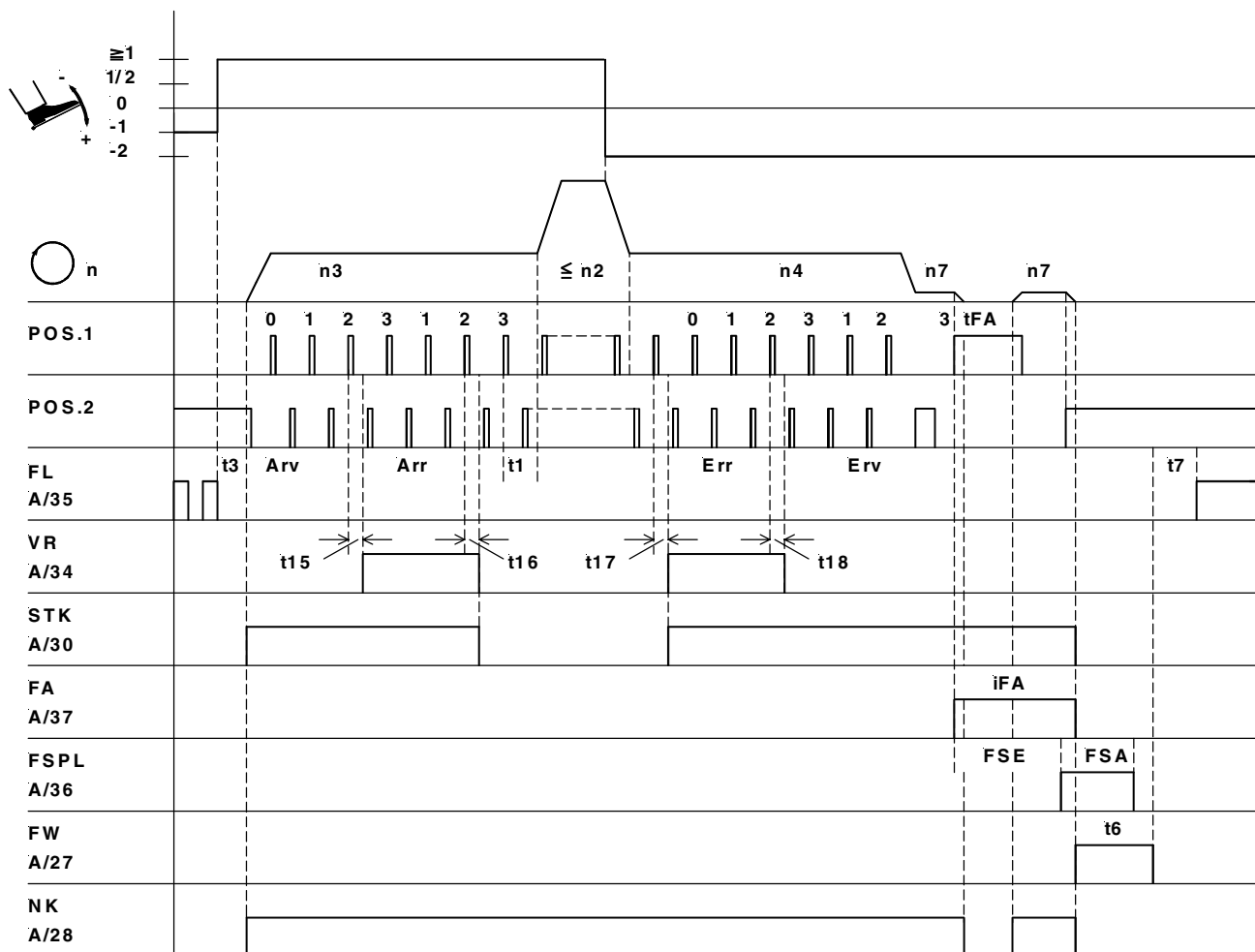

0214/REGEL

Mark	Function	Parameter	V810	V820
	Double start backtack	On	Key 1	Key 1
	Double end backtack	On	Key 2	Key 4
n2	Maximum speed	111		
n3	Start backtack speed	112		
n4	End backtack speed	113		
n7	Trimming speed	116		
Arv	Start backtack stitches forward	000		
Arr	Start backtack stitches backward	001		
Err	End backtack stitches backward	002		
Erv	End backtack stitches forward	003		
t15	Switch-on delay for start backtack	101		
t16	Switch-off delay for start backtack	102		
t17	Switch-on delay for end backtack	103		
t18	Switch-off delay for end backtack	104		
iFA	Thread trimmer activation angle	190		
FSA	Thread tension release switch-off delay	191		
FSE	Thread tension release activation angle	192		
tFA	Stop time for thread trimmer in position 1	193		
t1	Delay until speed release after start backtack	200		
t3	Start delay from lifted sewing foot	202		
t4	Full power of sewing foot lifting	203		
t5	Holding power of sewing foot lifting	204		
t6	Thread wiper ON period	205		
t7	Sewing foot lifting delay time after thread wiping	206		

Machine run with intermediate stop

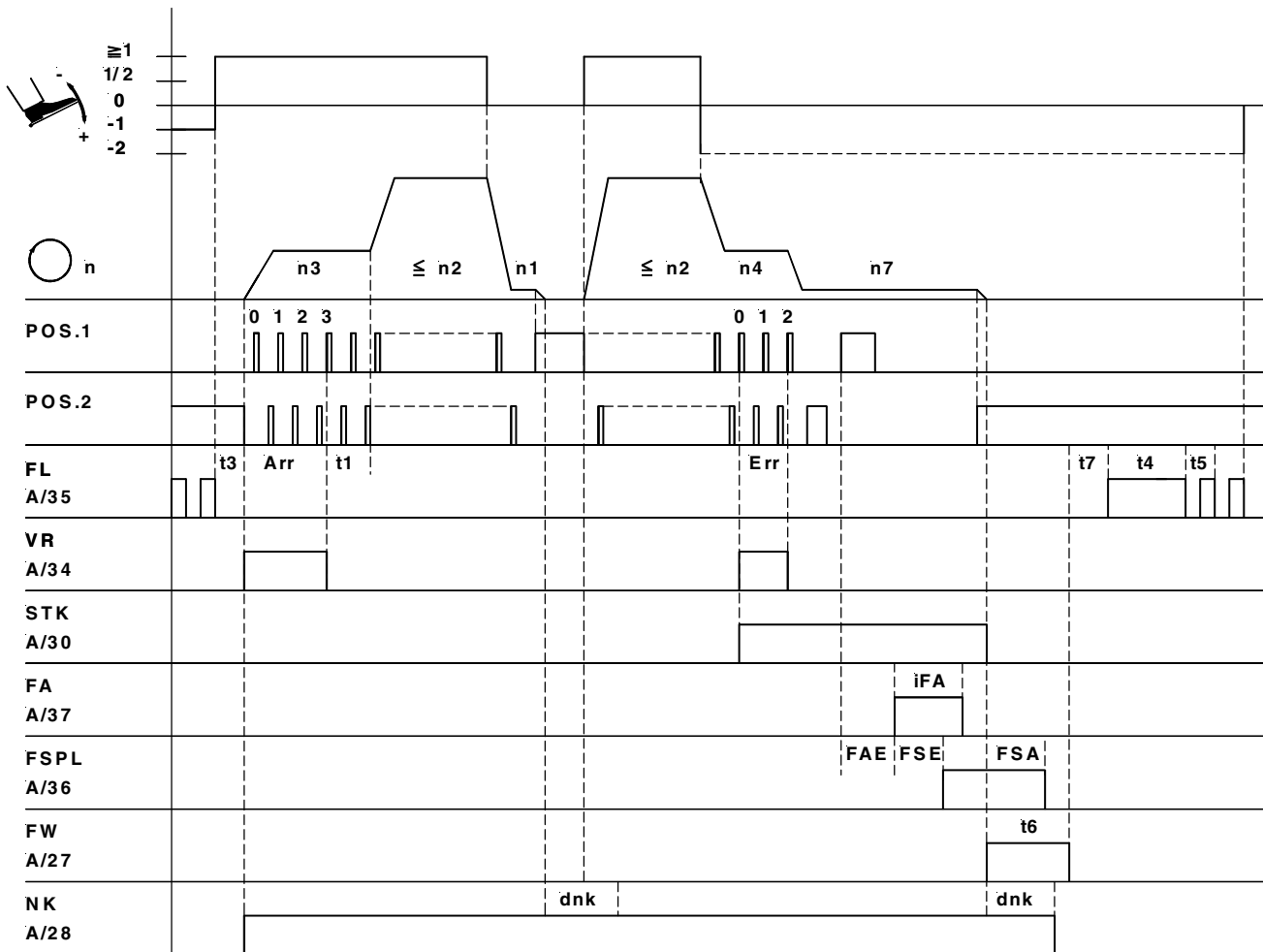

0214/LAUFZW

Mark	Function	Parameter	V810	V820
	Single start backtack	On	Key 1	Key 1
	Single end backtack	On	Key 2	Key 4
n1	Positioning speed	110		
n2	Maximum speed	111		
n3	Start backtack speed	112		
n4	End backtack speed	113		
n7	Trimming speed	116		
Arr	Start backtack stitches backward	001		
Err	End backtack stitches backward	002		
dnk	Needle cooling switch-off delay after the stop	183		
iFA	Thread trimmer activation angle	190		
FSA	Thread tension release switch-off delay	191		
FSE	Thread tension release activation angle	192		
FAE	Thread trimmer switch-on delay	194		
t1	Delay until speed release after start backtack	200		
t3	Start delay from lifted sewing foot	202		
t4	Full power of sewing foot lifting	203		
t5	Holding power of sewing foot lifting	204		
t6	Thread wiper ON period	205		
t7	Sewing foot lifting delay time after thread wiping	206		

Machine run with intermediate stop and short trimmer

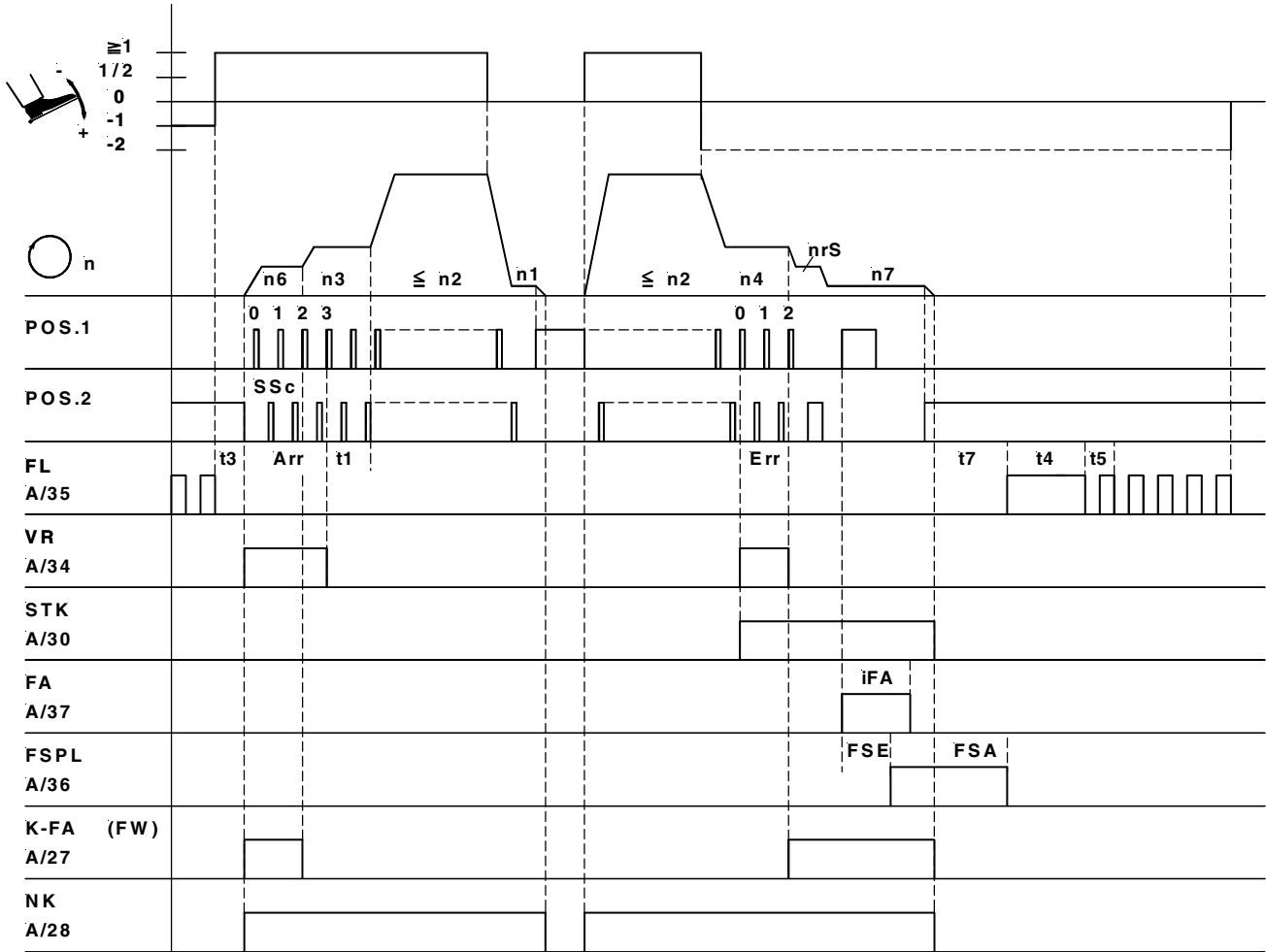

0214 / FAKURZ

Mark	Function	Parameter	V810	V820
Far	Single start backtack	On	Key 1 Key 2	Key 1 Key 4
	Single end backtack	On		
	Trimming stitch forward with signal output during softstart and 1 stitch before thread trimming until standstill (short trimmer)	136 = 3		
n1	Positioning speed	110		
n2	Maximum speed	111		
n3	Start backtack speed	112		
n4	End backtack speed	113		
n6	Softstart speed	115		
n7	Trimming speed	116		
nrS	Backtack synchronization speed	124		
Arr	Start backtack stitches backward	001		
Err	End backtack stitches backward	002		
SSc	Softstart stitches	100		
iFA	Thread trimmer activation angle	190		
FSA	Thread tension release switch-off delay	191		
FSE	Thread tension release activation angle	192		
t1	Delay until speed release after start backtack	200		
t3	Start delay from lifted sewing foot	202		
t4	Full power of sewing foot lifting	203		
t5	Holding power of sewing foot lifting	204		
t6	Thread wiper ON period	205		
t7	Sewing foot lifting delay time after thread wiping	206		

Machine run with intermediate stop and thread clamp On

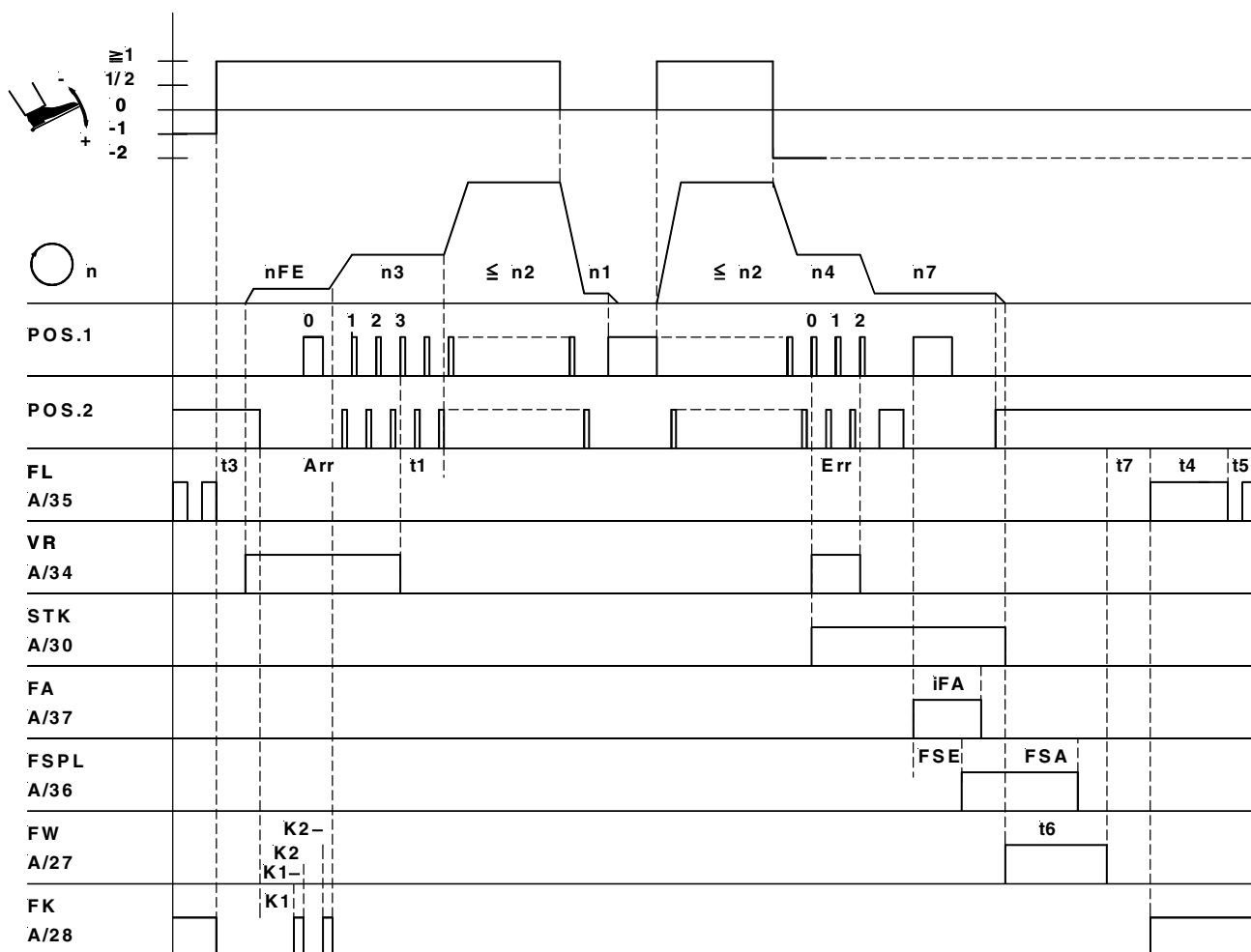

0214/LAUF- FK

Mark	Function	Parameter	V810	V820
FKL	Single start backtack Single end backtack Thread clamp	On On 154 = 1	Key 1 Key 2	Key 1 Key 4
n1	Positioning speed	110		
n2	Maximum speed	111		
n3	Start backtack speed	112		
n4	End backtack speed	113		
n7	Trimming speed	116		
nFE	Thread pull-in speed	fixed		
Arr	Start backtack stitches backward	001		
Err	End backtack stitches backward	002		
k1	Increments up to thread clamp enable (signal 1)	155		
k1-	Increments up to thread clamp disable (signal 1)	156		
k2	Increments up to thread clamp enable (signal 2)	157		
k2-	Increments up to thread clamp disable (signal 2)	158		
iFA	Thread trimmer activation angle	190		
FSA	Thread tension release switch-off delay	191		
FSE	Thread tension release activation angle	192		
t1	Delay until speed release after start backtack	200		
t3	Start delay from lifted sewing foot	202		
t4	Full power of sewing foot lifting	203		
t5	Holding power of sewing foot lifting	204		
t6	Thread wiper ON period	205		
t7	Sewing foot lifting delay time after thread wiping	206		

Trimming from intermediate stop

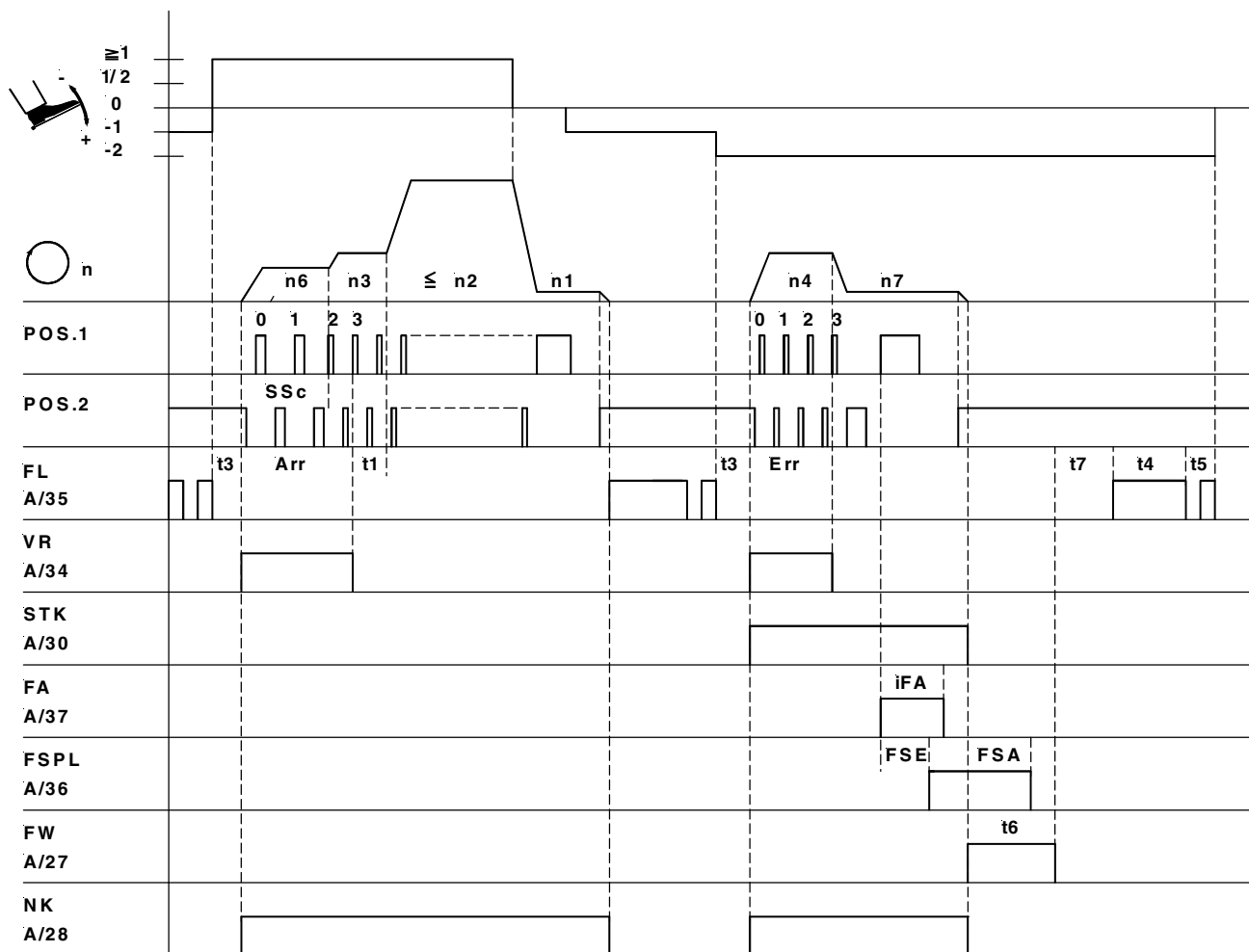

0214/FAZW

Mark	Function	Parameter	V810	V820
SSt	Basic position 2	On	Key 4	Key 7
	Single start backtack	On	Key 1	Key 1
	Single end backtack	On	Key 2	Key 4
	Softstart	134 = ON		
n1	Positioning speed	110		
n2	Maximum speed	111		
n3	Start backtack speed	112		
n4	End backtack speed	113		
n6	Softstart speed	115		
n7	Trimming speed	116		
Arr	Start backtack stitches backward	001		
Err	End backtack stitches backward	002		
SSc	Softstart stitches	100		
iFA	Thread trimmer activation angle	190		
FSA	Thread tension release switch-off delay	191		
FSE	Thread tension release activation angle	192		
t1	Delay until speed release after start backtack	200		
t3	Start delay from lifted sewing foot	202		
t4	Full power of sewing foot lifting	203		
t5	Holding power of sewing foot lifting	204		
t6	Thread wiper ON period	205		
t7	Sewing foot lifting delay time after thread wiping	206		
tSr	Stop time for ornamental backtack	210		

Seam end by stitch counting

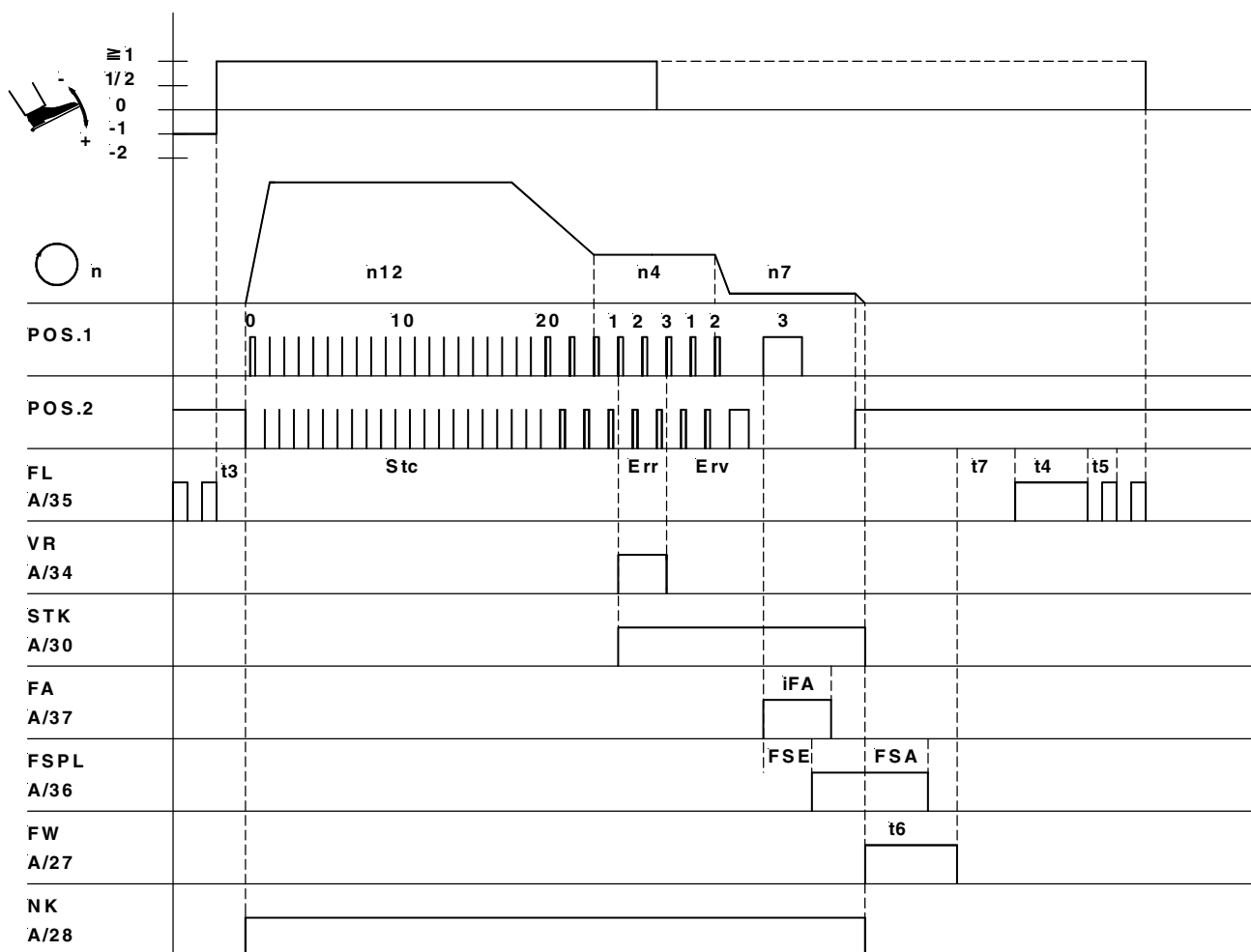

0214/ENDEZAE

Mark	Function	Parameter	V810	V820
	Stitch counting	On	---	Key 2
	Double end backtack	On	Key 2	Key 4
n4	End backtack speed	113		
n7	Trimming speed	116		
n12	Stitch counting speed	118		
Err	End backtack stitches backward	002		
Erv	End backtack stitches forward	003		
Stc	Stitches of the seam with stitch counting	007		
iFA	Thread trimmer activation angle	190		
FSA	Thread tension release switch-off delay	191		
FSE	Thread tension release activation angle	192		
t3	Start delay from lifted sewing foot	202		
t4	Full power of sewing foot lifting	203		
t5	Holding power of sewing foot lifting	204		
t6	Thread wiper ON period	205		
t7	Sewing foot lifting delay time after thread wiping	206		

End sensing by light barrier

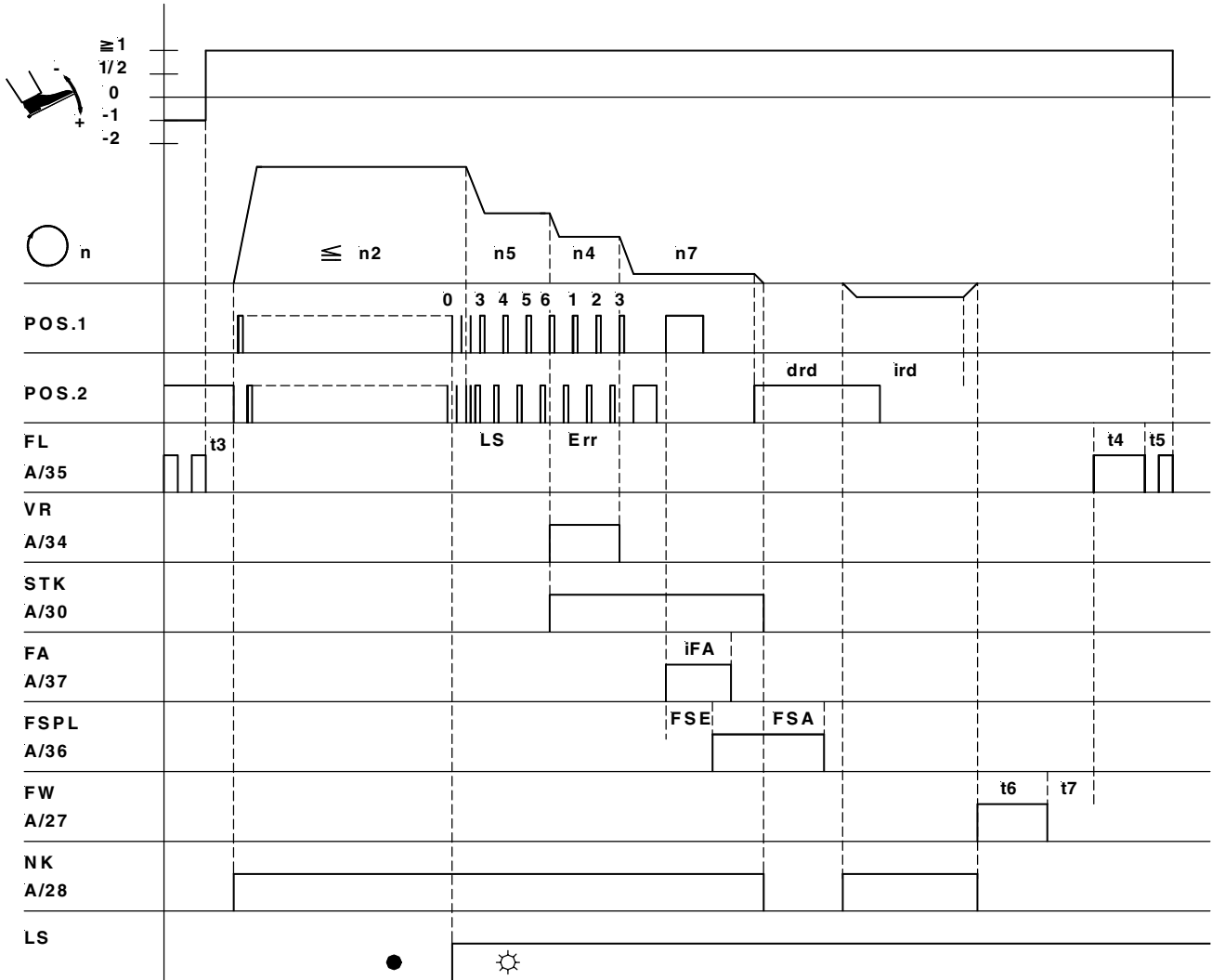

0214/ENDELS

Mark	Function	Parameter	V810	V820
LS	Single end backtack	On		
LSd	Light barrier	On	Key 2	Key 4
Frd	Light barrier covered/uncovered	009 = ON		
	Reversion	131 = ON		
		182 = ON		
n2	Maximum speed	111		
n3	Start backtack speed	112		
n5	Speed after light barrier sensing	114		
n7	Trimming speed	116		
Err	End backtack stitches backward	002		
LS	Light barrier compensating stitches	004		
ird	Number of reversion increments	180		
drd	Reversion switch-on delay	181		
iFA	Thread trimmer activation angle	190		
FSA	Thread tension release switch-off delay	191		
FSE	Thread tension release activation angle	192		
t3	Start delay from lifted sewing foot	202		
t4	Full power of sewing foot lifting	203		
t5	Holding power of sewing foot lifting	204		
t6	Thread wiper ON period	205		
t7	Sewing foot lifting delay time after thread wiping	206		

Machine run with ornamental backtack (parameter 217 = OFF)

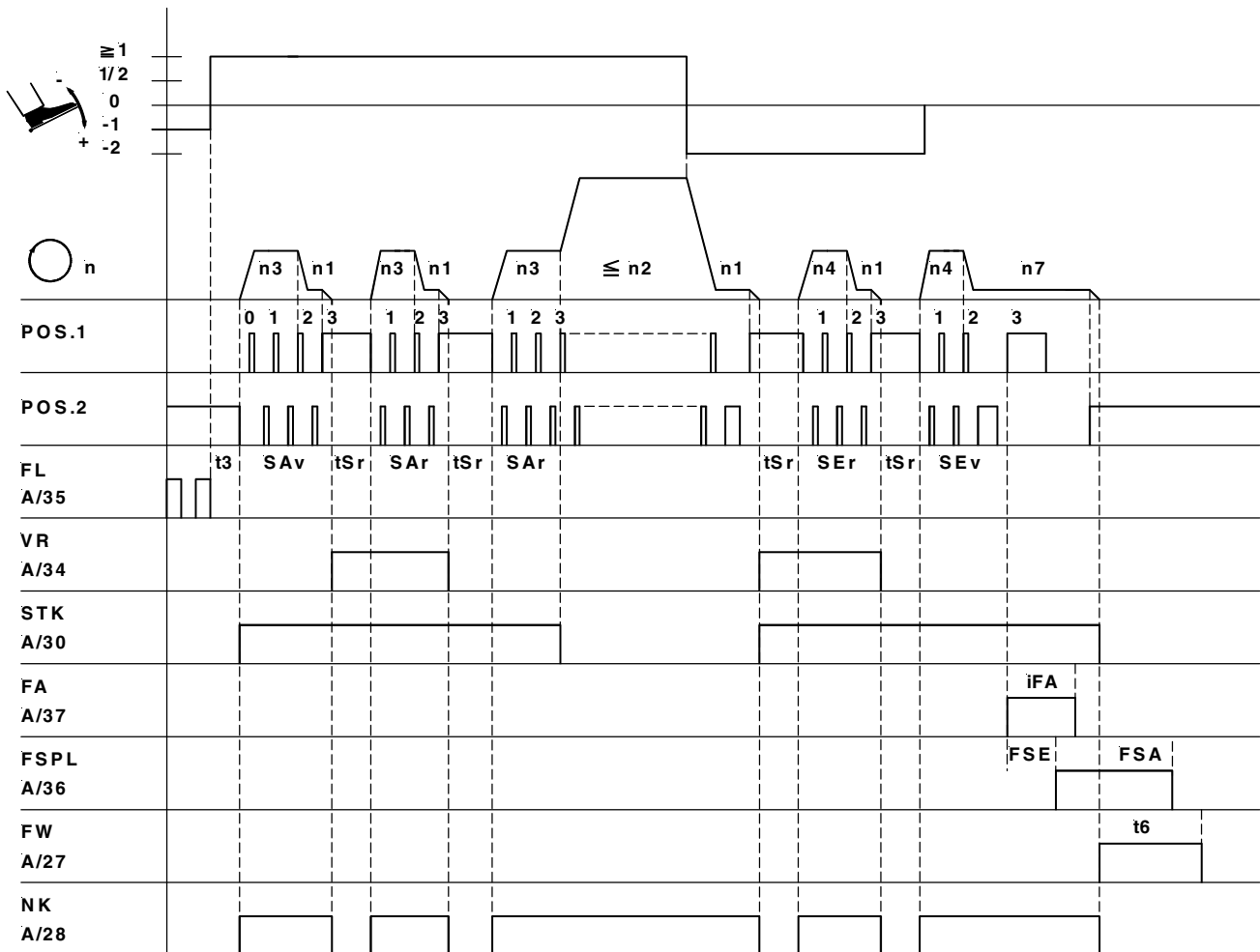

0214/LAUFZVR

Mark	Function	Parameter	V810	V820
SrS	Ornamental backtack On	135 = ON		
SLU	Normal stitch length On	137 = ON		
Zrv	Last counted forward section during ornamental backtack at the start of the seam On	215 = ON		
SSL	Stop time after the ornamental backtack at the start of the seam Off	217 = OFF		
n1	Positioning speed	110		
n2	Maximum speed	111		
n3	Start backtack speed	112		
n4	End backtack speed	113		
n7	Trimming speed	116		
SAv	Number of stitches for start ornamental backtack forward	080		
SAr	Number of stitches for start ornamental backtack backward	081		
SEr	Number of stitches for end ornamental backtack backward	082		
SEv	Number of stitches for end ornamental backtack forward	083		
iFA	Thread trimmer activation angle	190		
FSA	Thread tension release switch-off delay	191		
FSE	Thread tension release activation angle	192		
t3	Start delay from lifted sewing foot	202		
t6	Thread wiper ON period	205		
tSr	Stop time for ornamental backtack	210		

Machine run with ornamental backtack (parameter 217 = ON)

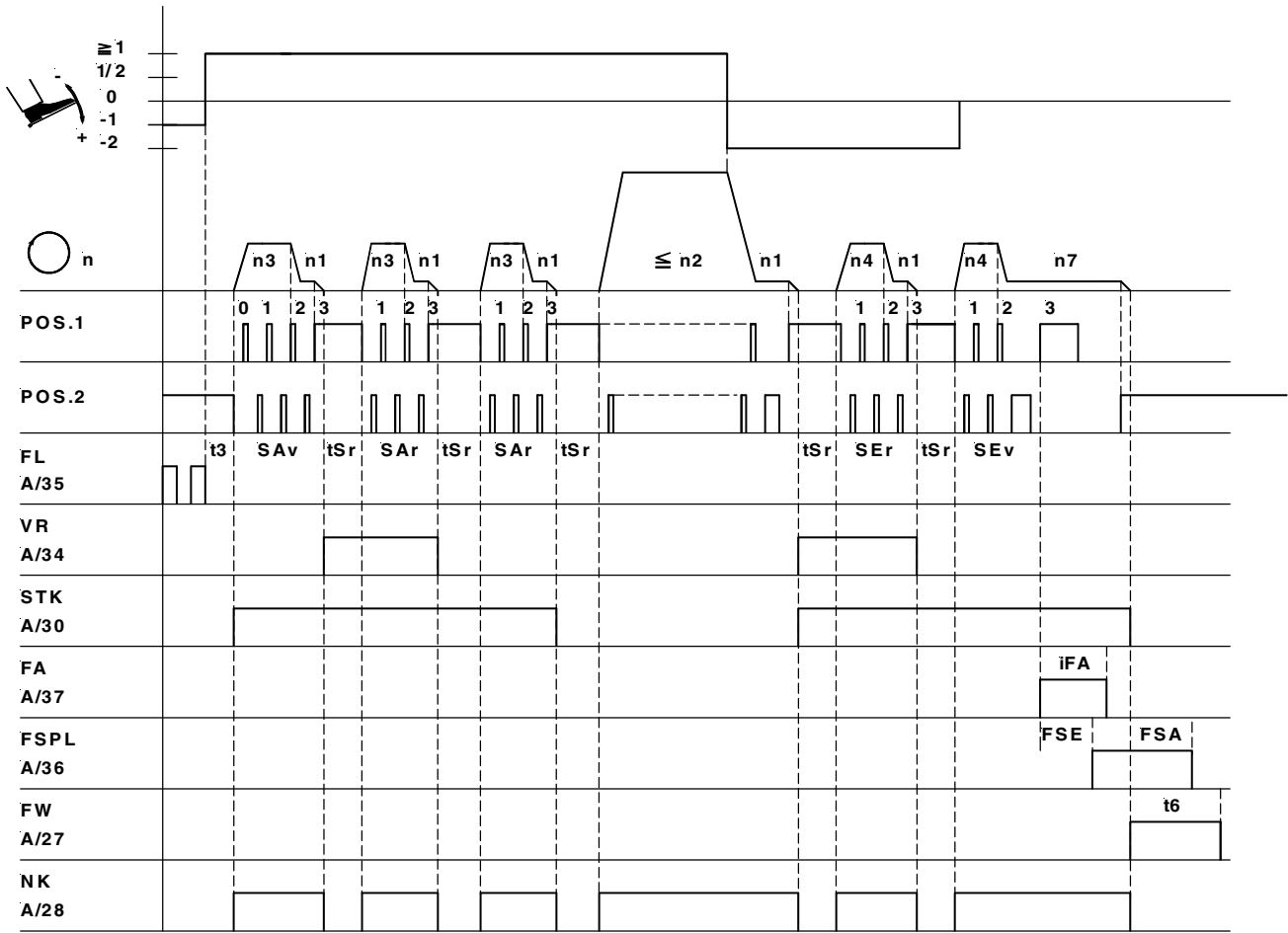

0214 / LAUFZVR2

Mark	Function	Parameter	V810	V820
SrS	Ornamental backtack On	135 = ON		
SLU	Normal stitch length On	137 = ON		
Zrv	Last counted forward section during ornamental backtack at the start of the seam On	215 = ON		
SSL	Stop time after the ornamental backtack at the start of the seam On	217 = ON		
n1	Positioning speed	110		
n2	Maximum speed	111		
n3	Start backtack speed	112		
n4	End backtack speed	113		
n7	Trimming speed	116		
SAv	Number of stitches for start ornamental backtack forward	080		
SAr	Number of stitches for start ornamental backtack backward	081		
SEr	Number of stitches for end ornamental backtack backward	082		
SEv	Number of stitches for end ornamental backtack forward	083		
iFA	Thread trimmer activation angle	190		
FSA	Thread tension release switch-off delay	191		
FSE	Thread tension release activation angle	192		
t3	Start delay from lifted sewing foot	202		
t6	Thread wiper ON period	205		
tSr	Stop time for ornamental backtack	210		

Machine run with high lift for walking foot

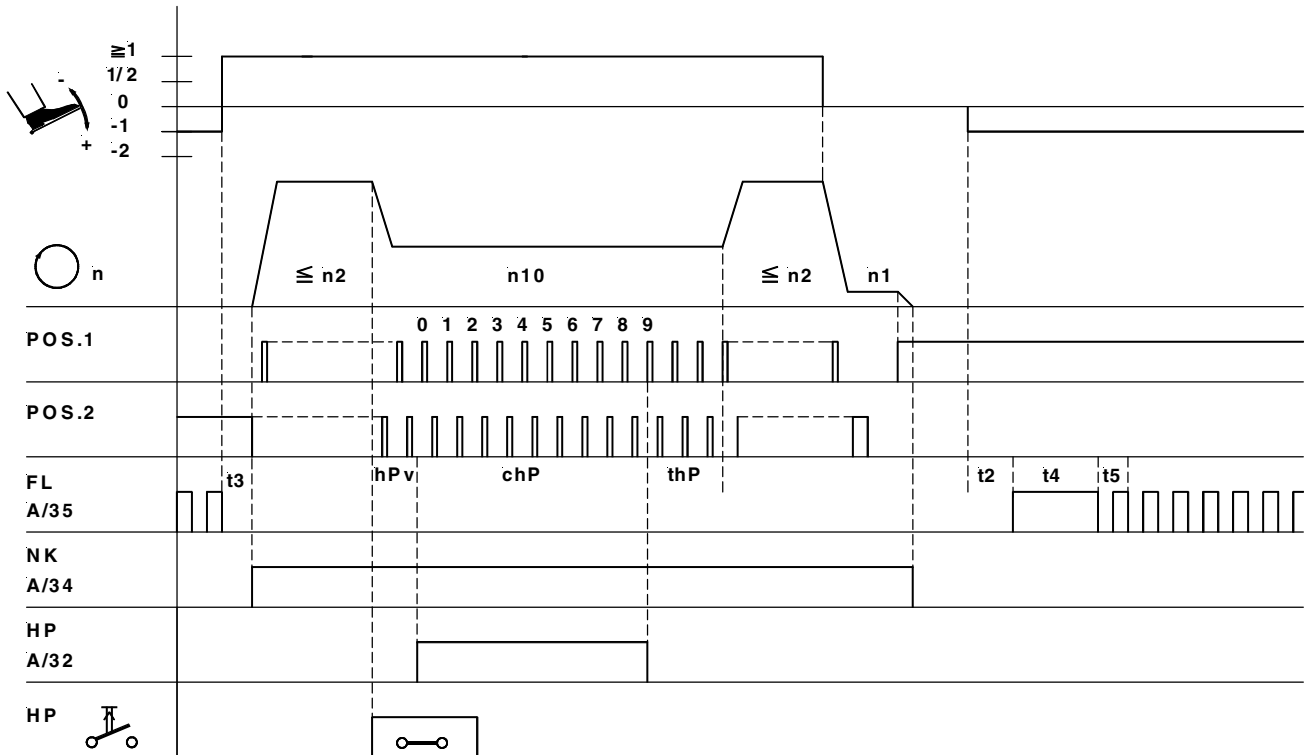

0214 / LAUFHUB

Mark	Function	Parameter	V810	V820
hPr	High lift for walking foot operational mode not stored	138 = OFF		
Fc6	Key on socket D/6 'function: high lift for walking foot'	149 = 1		
n1	Positioning speed	110		
n2	Maximum speed	111		
n10	High lift walking speed	117		
thP	High lift walking speed run-out time	152		
chP	Minimum high lift walking speed	184		
hPv	High lift for walking foot switch-on delay	189		
t2	Delay of sewing foot lifting with pedal in pos. -1	201		
t3	Start delay from lifted sewing foot	202		
t4	Full power of sewing foot lifting	203		
t5	Holding power of sewing foot lifting	204		

4 List of Parameters

4.1 Operator Level

Parameter	Designation	Unit	Limits		Preset for				Ind.	
			max	min	100Ω	220Ω	680Ω	1000Ω		
000	Arv	Number of stitches of start backtack forward	stitches	254	0	2	3	2	2	A
001	Arr	Number of stitches of start backtack backward	stitches	254	0	4	3	2	4	A
002	Err	Number of stitches of end backtack backward	stitches	254	0	3	2	2	3	A
003	Erv	Number of stitches of end backtack forward	stitches	254	0	3	3	5	3	A
004	LS	Light barrier compensating stitches (for long stitches)	stitches	254	0	4	4	4	4	A
005	LSF	Number of stitches of the light barrier filter for knitted fabrics	stitches	254	0	0	0	0	0	A
006	LSn	Number of light barrier seams		15	1	1	1	1	1	A
007	Stc	Number of stitches for the seam with stitch counting	stitches	254	0	10	10	10	10	A
008	-F-	A parameter from the technician level is assigned to key 9 on the V820 control panel 1 = Softstart On/Off 2 = Ornamental backtack On/Off 3 = High lift for walking foot operational mode stored = On / operational mode not stored = Off 4 = Needle cooling On/Off (only if parameter 185 = 1) 5 = Reversion On/Off		5	1	2	1	2	2	A
009	LS	Light barrier On/Off	ON/OFF			OFF	OFF	OFF	OFF	A
010	cLS	Light barrier compensating stitches (for normal stitch length)	stitches	254	0	8	8	8	8	A
013	FA	Thread trimmer On/Off	ON/OFF			ON	ON	ON	ON	A
014	FW	Thread wiper On/Off	ON/OFF			ON	OFF	OFF	OFF	A
015	StS	Stitch counting On/Off	ON/OFF			OFF	OFF	OFF	OFF	A
080	SAv	Number of start ornamental backtack stitches forward	stitches	254	0	3	3	2	3	A
081	SAr	Number of start ornamental backtack stitches backward	stitches	254	0	3	3	2	3	A
082	SEr	Number of end ornamental backtack stitches backward	stitches	254	0	3	3	2	3	A
083	SEv	Number of end ornamental backtack stitches forward	stitches	254	0	3	3	2	3	A
085	cFw	Number of stitches for thread monitor Parameter 195 = 1...3 Parameter 195 = 4 If parameter 195 = 4, the following functions will be activated upon pressing the appropriate key: >1 sec. = Thread monitor function is deactivated. <1 sec. = Counter is set to preset value.		2540 9990	0 0	0 0	0 0	0 0	0 0	A A
090	wAR	Repetitions of double start backtacking		254	0	0	0	0	0	H
091	wER	Repetitions of double end bakctacking		254	0	0	0	0	0	H
092	cb1	Number of catch backtacking stitches forward	stitches	254	0	0	0	0	0	H
093	cb2	Number of catch backtacking stitches backward	stitches	254	0	0	0	0	0	H

Note:

At the operator level, the parameter number (F-xxx) is not shown on the display, but the abbreviation (e. g. Arv) and the actual value (e. g. 002 for 2 stitches).

4.2 Technician Level

Code no. 1907 with control panel operation

Parameter	Designation	Unit	Limits		Preset for				Ind.	
			max	min	100Ω	220Ω	680Ω	1000Ω		
100	SSc	Number of softstart stitches	stitches	254	0	1	1	1	1	C
101	t15	Switch-on delay for the stitch regulator during start backtack	ms	255	0	0	0	0	0	E
102	t16	Switch-off delay for the stitch regulator during start backtack	ms	255	0	0	0	0	0	E
103	t17	Switch-on delay for the stitch regulator during end backtack	ms	255	0	0	0	0	0	E
104	t18	Switch-off delay for the stitch regulator during end backtack	ms	255	0	0	0	0	0	E
110	n1	Positioning speed	RPM	390	70	150	100	150	150	A
111	n2-	Upper limit setting range of the maximum speed	RPM	5000	n2_	4000	900	1700	3500	F
112	n3	Start backtacking speed	RPM	3000	200	1200	400	800	1200	A
113	n4	End backtacking speed	RPM	3000	200	1200	400	800	1200	A
114	n5	Speed after light barrier sensing	RPM	3000	200	1200	400	800	1200	A
115	n6	Softstart speed	RPM	2500	70	400	250	400	400	A
116	n7	Trimming speed	RPM	500	70	150	100	150	150	A
117	n10	High lift walking speed = speed limitation (DB2000)	RPM	2500	400	2000	400	800	2000	A
118	n12	Automatic speed for stitch counting according to setting of parameter 141	RPM	5000	400	1200	400	800	1200	A
119	nSt	Speed stage graduation 1 = linear 2 = slightly progressive 3 = highly progressive		3	1	1	1	1	1	A
120	nnk	Whenever this speed is exceeded, needle cooling is activated, if parameter 185 is set to "3"	RPM	5000	0	3000	3000	3000	3000	E
121	n2_	Lower limit setting range of the maximum speed	RPM	n2-	400	400	400	400	400	A
123	tnS	End backtack synchronization time	ms	500	0	40	0	0	40	A
124	nrS	End backtack synchronization speed	RPM	3000	100	500	400	800	500	A
125	n2A	Start backtack speed 2 (only if parameter 284 = ON)	RPM	3000	200	600	600	600	600	E
126	n2E	End backtack speed 2 (only if parameter 284 = ON)	RPM	3000	200	600	600	600	600	E
127	AkS	Acoustic signal during machine run blockage or thread monitor (pa. 195 = 4 and according to the setting of the number of stitches by means of parameter 085) 0 = Acoustic signal Off 1 = Acoustic signal from stop after execution of stitches to pressing key 8. 2 = Drive stops after execution of stitches. Sewing is possible up to the seam end. After that the acoustic signal is issued until key 8 is pressed. 3 = Drive stops after execution of stitches, and the acoustic signal is issued 5 times. Sewing is possible up to the seam end. After that the acoustic signal is issued until key 8 is pressed.		3	0	0	0	0	0	E
128	Asd	Start delay, when command "start" is given by covering the light barrier (only if parameter 129 = ON)	ms	2000	0	0	0	0	0	A

Technician Level

Code no. 1907 with control panel operation

Parameter	Designation	Unit	Limits		Preset for					Ind.	
			max	min	100Ω	220Ω	680Ω	1000Ω			
129	ALS	Automatic start by light barrier On/Off: machine start by covering the light barrier, without having heeled the pedal back to the basic position. Additional prerequisites: - Parameter 132 = ON - Function "light barrier sensing" enabled on the control panel - Initiation of the first "normal" seam section (pedal in the basic position) - Cover light barrier - Press pedal forward - Keep pedal pressed forward Deactivate this function by heeling the pedal back to the basic position.	ON/OFF			OFF	OFF		OFF	OFF	A
130	LSF	Light barrier filter for knitted fabrics On/Off	ON/OFF			OFF	OFF		OFF	OFF	A
131	LSd	OFF = Light barrier sensing "covered" ON = Light barrier sensing "uncovered"	ON/OFF			ON	ON		ON	ON	A
132	LSS	OFF = Machine start possible with light barrier uncovered or covered. ON = Machine start blocked with light barrier uncovered if pa. 131 = ON. Machine start blocked with light barrier covered if pa. 131 = OFF.	ON/OFF			ON	ON		ON	ON	A
133	LSE	Thread trimming operation, when completing the seam after light barrier sensing On/Off	ON/OFF			ON	ON		ON	ON	A
134	SSt	Softstart On/Off	ON/OFF			ON	ON		ON	ON	A
135	SrS	Ornamental backtack On/Off	ON/OFF			OFF	OFF		OFF	OFF	A
136	FAr	Power transistor function on A/27 (functions: thread trimmer, thread wiper and short trimmer) 0 = Trimming stitch forward and thread wiper function On 1 = Trimming stitch backward and thread wiper function On 2 = Trimming stitch forward with short trimmer signal On. Thread wiper function Off. 3 = Trimming stitch forward with signal for stitch length reduction during softstart and signal for short trimmer On. Thread wiper function Off. 4 = Trimming stitch forward with signal for stitch length reduction during softstart. Thread wiper function Off.		4	0	0	0		1	0	E
137	SLU	Stitch length during backtack OFF= long stitches ON = normal stitches	ON/OFF			ON	OFF		OFF	OFF	A
138	hPr	OFF = High lift for walking foot operational mode not stored ON = High lift for walking foot operational mode stored	ON/OFF			OFF	OFF		OFF	OFF	A
139	nIS	Display of machine speed On/Off	ON/OFF			OFF	OFF		OFF	OFF	A
140	nh1	Mode "key needle up/down" on socket A/6 1 = Needle up 2 = Needle up/down 3 = Single stitch 4 = Single stitch with stitch length switching 5 = Needle up if outside position 2 6 = Machine stop in position 2 and sewing foot up. Machine run blockage symbol blinking on V820 and "stop" on V810, respectively. After power Off/On the drive is ready again.		6	1	1	2		2	1	E

Technician Level

Code no. 1907 with control panel operation

Parameter	Designation	Unit	Limits		Preset for					Ind.
			max	min	100Ω	220Ω	680Ω	1000Ω		
141	SGn	Speed status for the seam with stitch counting 0 = Speed controllable by the pedal up to the set maximum speed (parameter 111) 1 = Fixed speed (parameter 118) without influence by the pedal (machine stop by pressing the pedal to the basic position) 2 = Limited speed controllable by the pedal up to the set limit (parameter 118) 3 = At fixed speed (parameter 118) can be interrupted by full heelback	3	0	1	1		1	1	A
142	SFn	Speed status for the free seam and for the seam with light barrier 0 = Speed controllable by the pedal up to the set maximum speed (parameter 111) 1 = Fixed speed (parameter 118) without influence by the pedal (machine stop by pressing the pedal to the basic position) 2 = Limited speed controllable by the pedal up to the set limit (parameter 118) 3 = At fixed speed (parameter 118) can be interrupted by full heelback (only in conjunction with light barrier On, otherwise like setting 0)	3	0	0	0		0	0	A
143	mnF	Mode "key speed limitation" (DB2000) on socket A/9 1 = Speed n10 limited (DB2000) 2 = Speed n10 fixed	2	1	1	1		1	1	A
144	nh2	Mode "key needle up/down" on socket D/1 1 = Needle up 2 = Needle up/down 3 = Single stitch 4 = Single stitch with stitch length switching 5 = Needle up if outside position 2 6 = Machine stop in position 2 and sewing foot up. Machine run blockage symbol blinking on V820 and "stop" on V810, respectively. After power Off/On the drive is ready again.	6	1	1	1		1	1	E
145	StL	Normal/long stitches with/without speed limitation. Key on socket D/2. 1 = Normal/long stitches without speed limitation 2 = Normal/long stitches without speed limitation (DB2000) 3 = Normal/long stitches without speed limitation (DB3000)	3	1	1	1		1	1	A
146	mFd	Function of the key on socket D/4. 1 = Sewing foot pressure reduction with speed limitation (DB2000) 2 = Sewing foot pressure reduction with speed limitation (DB3000) 3 = Roller 4 = Sewing foot pressure reduction inverted relative to the sewing foot	4	1	3	3		3	3	A
147	Fc3	Function of the key on socket D/3 1 = Thread tension reduction 2 = Backtack suppression/recall 3 = Roller	3	1	1	1		1	1	F
148	Fc5	Function of the key on socket D/5 1 = Speed limitation (DB3000) 2 = Intermediate backtack	2	1	2	2		2	2	A

Technician Level

Code no. 1907 with control panel operation

Parameter	Designation	Unit	Limits		Preset for					Ind.	
			max	min	100Ω	220Ω	680Ω	1000Ω			
149	Fc6	Function of the key on socket D/6 1 = Hight lift for walking foot 2 = Thread tension reduction 3 = Roller	3	1	1	1		1	1	F	
152	thP	Run-out time of the high lift walking speed after disabling the high lift for walking foot	ms	500	80	100	100		100	100	A
153	brt	Braking power at machine standstill		50	0	6	6		6	6	A
154	FkL	Thread clamp function 0 = Thread clamp Off 1 = Thread clamp function when using the values of parameters 155...158 2...7 = Preset values (see table in the instruction manual) The thread clamp functions are performed at a fixed speed of 250 RPM!		7	0	0	0		0	0	F
155	k1	Increments up to enabling of the thread clamp (signal 1)	incr.	500	0	100	100		100	100	A
156	k1-	Increments up to disabling of the thread clamp (signal 1). This parameter setting value must not be lower than that of parameter 155.	incr.	500	0	200	200		200	200	A
157	k2	Increments up to enabling of the thread clamp (signal 2)	incr.	500	0	0	0		0	0	A
158	k2-	Increments up to disabling of the thread clamp (signal 2). This parameter setting value must not be lower than that of parameter 157.	incr.	500	0	0	0		0	0	A
161	drE	Direction of motor rotation 0 = Clockwise rotation 1 = Counterclockwise rotation		1	0	1	1		1	1	A
170	Sr1	Setting the reference position: ****) - Press the E key. - Press the >> key. - Position 0 = Needle point at the height of the needle plate, from downward movement of the needle in the direction of rotation of the motor shaft.									A
171	Sr2	Setting the needle positions: ****) Press key E. Press key >>. 1 = Position 1 (leading edge) Press key E. 2 = Position 2 (leading edge) Press key E. 1A= Position 1 (trailing edge) Press key E. 3 = Position 3 no function Press key E. 3A= Position 3 no function (for changing the values turn handwheel or press key +/-) Press key P twice. Settings are completed!		510	0	170	150		160	60	C
				510	0	440	422		440	466	C
				510	0	250	250		210	200	A
				510	0	0	0		0	0	A
				510	0	0	0		0	0	A
172	Sr3	Display on the V810 control panel: Pos. 1 to 1A (lefthand arrow above key 4 On) Pos. 2 to 2A (righthand arrow above key 4 On) Function active only after sewing has been started once!									
172	Sr3	Display on the V820 control panel: Pos. 1 to 1A (lefthand arrow above key 7 On) Pos. 2 to 2A (righthand arrow above key 7 On) Function active only after sewing has been started once!									

****) For more detailed instructions see instruction manual!

Technician Level

Code no. 1907 with control panel operation

Parameter	Designation	Unit	Limits		Preset for					Ind.	
			max	min	100Ω	220Ω	680Ω	1000Ω			
173	Sr4	<p>Checking of the signal outputs and inputs using the V810/V820 control panels</p> <ul style="list-style-type: none"> - Select the desired output using the +/- key - Activate the selected output using the >> key <p>01 = Backtacking on socket A/34 02 = Sewing foot lift on socket A/35 03 = Thread trimmer on socket A/37 04 = Thread wiper on socket A/27 05 = Stitch length switching on socket A/30 06 = Thread tension release on sockets A/36, B/5, C/5 07 = Thread tension reduction on socket A/20 08 = Needle cooling on socket A/28 09 = Motor running on sockets A/26, B/6 10 = High lift for walking foot on socket A/32 11 = No assignment on socket A/22 12 = LED for needle up/down on socket D/9 13 = LED for long stitch on socket D/10 14 = Thread clamp on socket A/18 15 = LED for high lift for walking foot on socket A/31 16 = LED for righthand thread monitor on socket A/25 17 = LED for sewing foot pressure reduction on socket D/12 18 = LED for thread tension reduction/backtack suppression/recall on socket D/11 19 = Sewing foot pressure reduction on socket A/21 20 = LED for lefthand thread monitor on socket A/23 21 = Flip-flop on socket C/6 22 = LED for high lift limitation/thread tension reduction on socket D/14 23 = LED for backtack suppression/recall on socket A/24 24 = LED for speed limitation 3000 / intermediate backtack on socket D/13 (effective only in conjunction with the key on socket D/5) 25 = LED for long stitch on socket A/29 26 = No assignment on socket A/17 27 = No assignment on socket A/16 28 = Roller feed on socket A/15</p> <p>OFF/ON = By actuating the switches connected to the control, the function of these switches is checked and ON/OFF is displayed on the V810/V820 control panels</p>									
179	Sr5	<p>V820 control panel display: Control program number with index and identification number. V810 control panel display: Upon pressing the "<<" key, data will be displayed in succession.</p>									
180	ird	Number of reversing increments	incr.	400	20	40	40		30	90	C
181	drd	Switch-on delay of reverse motor rotation	ms	990	0	0	0		0	0	A
182	Frd	Reverse motor rotation On/Off	ON/OFF			OFF	OFF		OFF	OFF	A
183	dnk	Switch-off delay of needle cooling after stop or falling below the switch speed (parameter 120)	ms	2550	0	2500	2500		2500	2500	E
184	chP	Minimum number of stitches for high lift for walking foot	stitches	100	0	0	0		0	0	A

Technician Level

Code no. 1907 with control panel operation

Parameter	Designation	Unit	Limits		Preset for				Ind.		
			max	min	100Ω	220Ω	680Ω	1000Ω			
185	Fnk	Function of the output "needle cooling" 1 = Needle cooling 2 = Reserved for option 3 = Needle cooling depending on speed (the switch speed can be set using pa. 120)	3	1	1	1		1	1	E	
186	ctw	Stitches until roller lowering	stitches	100	0	10	10		10	10	A
187	Stn	Stitch length in the next seam (after the thread trimming operation) 1 = The selected stitch length remains On. 2 = Switch to long stitches after thread trimming. 3 = Switch to normal stitches after thread trimming.		3	1	1	1		1	1	A
188	hP	Minimum speed level for high lift for walking foot Maximum speed level for high lift for walking foot Assignment of maximum speed (parameter 111) and minimum speed (parameter 117 = high lift walking speed) to the 21 speedomat levels. Display example: 2740 05 11 19 05 = Display of the level up to which the maximum speed is effective. 19 = Display of the level up to which the minimum speed is effective. 11 = Display of the level set on the speedomat (potentiometer). 2740 = Corresponding speed See instruction manual on how to change the setting!		21 21	1 1						A A
189	hPv	High lift for walking foot switch-on delay	ms	2550	0	0	0		0	0	A
190	iFA	Activation angle of the thread trimmer (1 increment corresponds to 0.7°) Set to 180 with series N291 and 8967!	incr.	450	0	450	450		450	80	E
191	FSA	Thread tension release switch-off delay	ms	990	0	50	50		50	50	A
192	FSE	Angle of thread tension release switch-on delay (i increment corresponds to 0.7°)	incr.	450	0	0	0		210	260	C
193	tFA	Thread trimmer stop time	ms	500	0	0	0		0	30	A
194	FAE	Angle of thread trimmer switch-on delay	incr.	450	0	0	0		0	0	A
195	rFW	Thread monitor mode 0 = No thread monitor function. 1 = Model 270 or short seams. Without stop, sewing foot down after thread trimming. 2 = Model 767/N291. With stop, sewing foot up after thread trimming. 3 = Model 767/N291. With stop, sewing foot down after thread trimming. 4 = With thread monitor stitch counting (max. 9990 stitches) Number of stitches according to setting of parameter 085.		4	0	0	0		0	0	A

Technician Level

Code no. 1907 with control panel operation

Parameter	Designation	Unit	Limits		Preset for				Ind.	
			max	min	100Ω	220Ω	680Ω	1000Ω		
196	kFn	<p>0 = Thread tension release and thread tension reduction "Off" during sewing foot lifting.</p> <p>1 = Thread tension release and thread tension reduction "On" during sewing foot lifting in the seam.</p> <p>2 = Thread tension release and thread tension reduction "On" during sewing foot lifting after thread trimming.</p> <p>3 = Thread tension release and thread tension reduction "On" during sewing foot lifting in the seam and after thread trimming.</p> <p>If parameter 147 = 1 (key on socket D/3) or parameter 149 = 2 (key on socket D/6), thread tension reduction can be enabled at any time. The operational mode of the keys is stored.</p>	3	0	0	0		0	0	A
197	kFh	<p>0 = Coupling thread tension reduction with high lift for walking foot and speedomat Off.</p> <p>1 = Thread tension reduction is disabled and high lift for walking foot enabled using the key on socket A/7. The speedomat has no effect.</p> <p>2 = When reaching the high lift walking speed by adjusting the speedomat, thread tension reduction is disabled. The key on socket A/7 has no effect.</p> <p>3 = When reaching the high lift walking speed by adjusting the speedomat, thread tension reduction is disabled. The key on socket A/7 works as with setting 1.</p> <p>If parameter 147 = 1 (key on socket D/3) or parameter 149 = 2 (key on socket D/6), thread tension reduction can be enabled at any time. The operational mode of the keys is stored.</p>	3	0	0	0		0	0	A
198	mmL	<p>1 = Motor running</p> <p>2 = 2nd thread tension release n > Param. 120, FSPL2 = On n < Param. 120, FSPL2 = Off</p> <p>3 = 2nd thread tension release n < Param. 120, FSPL2 = On n > Param. 120, FSPL2 = Off</p>	3	1	2	2		2	2	H

4.3 Supplier Level

Code no. 3112 with control panel operation

Parameter	Designation	Unit	Limits		Preset for				Ind.	
			max	min	100Ω	220Ω	680Ω	1000Ω		
200	t1	Delay until speed release after start backtack	ms	500	0	50	50	50	50	A
201	t2	Sewing foot lift switch-on delay with half heelback	ms	500	20	80	80	80	80	A
202	t3	Start delay after disabling the sewing foot lift signal	ms	500	0	80	80	120	80	C
203	t4	Time of full power of sewing foot lifting	ms	600	0	200	200	200	200	A
204	t5	Holding power for sewing foot lifting Stages 0, 1...7 Stage 0 → 100% high holding power Stage 1 → 12.5% low holding power Stage 7 → 87.5%				3	3	3	3	A
205	t6	Thread wiper time	ms	500	0	100	100	100	100	A
206	t7	Delay from end of thread wiper until sewing foot lifting On	ms	800	0	30	30	30	30	A
207	br1	Braking effect when modifying the preset value ≤ 4 stages Preset value if parameter 225 = 0 Preset value if parameter 225 = 1 Preset value if parameter 225 = 2 Preset value if parameter 225 = 3		255	1	25	25	25	25	A A A A
208	br2	Braking effect when modifying the preset value ≥ 5 stages Preset value if parameter 225 = 0 Preset value if parameter 225 = 1 Preset value if parameter 225 = 2 Preset value if parameter 225 = 3		255	1	60	60	60	60	A A A A
210	tSr	Stop time for switching the stitch regulator in the ornamental backtack	ms	500	0	100	270	150	100	C
212	t10	Time of full power of backtacking	ms	600	0	200	200	200	200	A
213	t11	Holding power for backtacking Stages 0, 1...7 Stage 0 → 100% high holding power Stage 1 → 12.5% low holding power Stage 7 → 87.5%				4	4	4	4	A
215	Zrv	OFF = Last counted forward section in the start backtack OFF ON = Last counted forward section in the start backtack ON	ON/OFF			ON	ON	ON	ON	A
216	FLS	OFF = Fast disabling of sewing foot lift Off ON = Fast disabling of sewing foot lift On	ON/OFF			ON	ON	ON	ON	A
217	SSL	OFF = Stop time after the ornamental backtack at the start of the seam Off ON = ,Stop time after the ornamental backtack at the start of the seam On, if parameter 135 / 137 = ON	ON/OFF			OFF	OFF	OFF	OFF	G
220	ALF	Accelerating power of the drive Preset value if parameter 225 = 0 Preset value if parameter 225 = 1 Preset value if parameter 225 = 2 Preset value if parameter 225 = 3		255	5	32	32	32	32	A A A A

Supplier Level

Code no. 3112 with control panel operation

Parameter	Designation	Unit	Limits		Preset for				Ind.	
			max	min	100Ω	220Ω	680Ω	1000Ω		
225	rEG	0 = Normal machines 1 = Medium-duty machines 2 = Heavy-duty machines 3 = Machine models 4180 and 4280 The preset values of parameters 207, 208 and 220 change depending on the setting of parameter 225. See respective parameters.	3	0	0	2		3	0	C
231	Sn1	Execution of the 1st stitch after power On at positioning speed.	ON/OFF			OFF	OFF	OFF	OFF	A
260	PLc	Time interval which can be varied by means of the number of stitches performed after sewing foot lowering until roller lowering in the seam On/Off (setting by means of parameter 186). OFF = Time interval which can be varied by the number of stitches performed Off ON = Time interval which can be varied by the number of stitches performed On	ON/OFF			OFF	OFF	OFF	OFF	A
261	FLk	0 = Roller not coupled with sewing foot lift or backtack 1 = Lift roller with sewing foot lift or backtack 2 = Lift roller with sewing foot lift 3 = Lift roller with backtack	3	0	1	1		1	1	A
262	hPt	0 = Roller remains lowered when enabling high lift for walking foot. 1 = Roller is lifted when enabling high lift for walking foot.	1	0	0	0		0	0	A
275	Std	Seam suppression when 0 stitches have been set	1	0	0	0		0	0	A
276	dkn	0 = Correction seam Off 1 = Correction seam On 2 = Interruption of seam or pattern by thread trimming	2	0	0	0		0	0	A
277	nFS	Select: Switch from one seam or pattern to the next 0 = Switch from one seam to the next 1 = Switch from one pattern to the next	1	0	0	0		0	0	E
280	SEL	Display of the select resistor values (socket A/1-4) for the following machine series: 100Ω = 271 N291, 8967 (set parameter 190 to 180) 220Ω = 204, 205, 221, 266, 366 680Ω = 069, 267, 268, 269, 4180, 4280 1000Ω = 381, 382, 467, 767, 768	1000	100	100	220		680	1000	E
281	Pd0	New sewing start after machine run blockage ON = Immediate start OFF = Only with pedal in position 0 (neutral)	ON/OFF			ON	ON	ON	ON	A
282	LoS	Functioning of the switch for machine run blockage 0 = Make contact (N.O.) 1 = Break contact (N.C.)	1	0	0	0		0	0	A
283	LSP	Function "machine run blockage" 0 = Function Off 1 = Blockage 1, without positioning 2 = Blockage 2, with positioning	2	0	1	1		1	1	A
284	StP	Start and end backtack can be interrupted with pedal in position 0 (neutral) On/Off	ON/OFF			OFF	OFF	OFF	OFF	A

Supplier Level

Code no. 3112 with control panel operation

Parameter	Designation	Unit	Limits		Preset for				Ind.		
			max	min	100Ω	220Ω	680Ω	1000Ω			
287	dbA	Speed limitation (n11) DB3000 for manual backtack 0 = Speed limitation Off 1 = Speed limitation On	1	0	0	0		0	0	A	
288	n9	Speed limitation (n9) for manual ornamental backtack	RPM	3000	200	1200	400		800	1200	A
289	n11	Speed limitation (n11) DB3000 for manual backtack	RPM	3000	500	3000	400		1700	3000	A
291	810	Selection of the slide-in strip number for control panel V810 (illustration of slide-in strips see chapter 'Slide-in Strips Control Panel V810'). Function of key 4 on the control panel: Strip 1-9 Basic position 1 or 2 Strip 10 Thread trimmer/thread wiper On/Off		10	1	1	1		1	1	E
293	tF1	Selection of the input function using key (A) "F1" on the V810 control panel 0 = No function 1 = Needle up 2 = Needle up/down 3 = Single stitch (basting stitch) 4 = Single stitch with stitch length switching 5 = Needle up if outside position 2 6 = Switch stitch length 7 = Thread tension 8 = Sewing foot pressure 9 = Roller 10 = Speed limitation DB3000 11 = No function 12 = No function 13 = High lift for walking foot operational mode stored/not stored according to setting of parameter 138 14 = No function 15 = No function 16 = Intermediate backtack 17 = Backtack suppression / recall 18 = Coupling the sewing foot with thread tension release (parameter 196 > 0) On/Off 19 = Set thread monitor counting (parameter 195 = 4)		19	0	17	17		17	17	A
294	tF2	Selection of the input function using key (B) "F2" on the V810/V820 control panel Functions of the key as with parameter 293		19	0	1	1		1	1	A
297	tFL	Time monitoring of sewing foot lift (monitoring off at '0')	sec	250	0	0	0		0	0	C

5 Error Displays

General Information		
On the V810	On the V820	Signification
InF A1	InF A1	Pedal not in neutral position, when turning the machine on
-StoP- blinking	Symbol blinking	Machine run blockage
InF A3	InF A3	The position to which all position values refer has not been stored (reference position missing)
InF A5	InF A5	Emergency run, identification of an invalid machine select

Programming Functions and Values (Parameters)		
On the V810	On the V820	Signification
Returns to the first digit	Like V810 + display InF F1	Wrong code number or parameter number input

Serious Condition		
On the V810	On the V820	Signification
InF E1	InF E1	After power On, position transmitter or commutation transmitter defective or connecting cables have been changed by mistake. During machine run or after a sewing operation, only position transmitter defects can be identified.
InF E2	InF E2	Line voltage too low, or time between power off and power on too short.
InF E3	InF E3	Machine blocked or does not reach the desired speed.
InF E4	InF E4	Control disturbed by deficient grounding or loose contact.

Hardware Disturbance		
On the V810	On the V820	Signification
InF H1	InF H1	Commutation transmitter cord or frequency converter disturbed.
InF H2	InF H2	Processor disturbed

6 Slide-in Strips for the V810 Control Panel

											1	→
									F1	F2	2	→
									F1		3	→
									F1	F2	4	→
									F1	F2	5	→
									F1	F2	6	→
									F1	F2	7	→
									F1	F2	8	→
									F1	A,B,C,D	9	→
											10	→

KL2513

For your notes:

For your notes:

For your notes:



FRANKL & KIRCHNER GMBH & CO KG
SCHEFFELSTRASSE 73 – 68723 SCHWETZINGEN – GERMANY
PHONE: +49-6202-2020 – FAX: +49-6202-202115
E-mail: info@efka.net – <http://www.efka.net>



OF AMERICA INC.
3715 NORTHCREST ROAD – SUITE 10 – ATLANTA – GEORGIA 30340
PHONE: +1 (770) 457-7006 – FAX: +1 (770) 458-3899 – E-mail: efkaus@bellsouth.net



ELECTRONIC MOTORS SINGAPORE PTE. LTD.
67, AYER RAJAH CRESCENT 05-03 – SINGAPORE 139950
PHONE: +65-67772459 – FAX: +65-67771048 – E-mail: efkaems@efka.net