

SINGER

147-93,-94,-121,-122

20692

INSTRUCTIONS
FOR USING
SINGER*
SEWING MACHINES
147-93, 147-94, 147-121
AND 147-122

INDEPENDENT UPPER AND UNDER FEED
TWO AND THREE—THREAD CHAIN STITCH
AUTOMATIC OILING SYSTEM

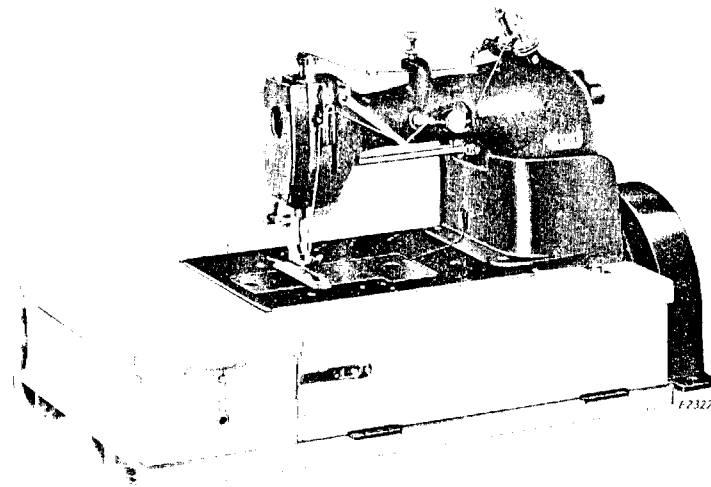

CAUTION:—Special attention is called to the lubricating instructions
on pages 3 to 6

THE SINGER MANUFACTURING COMPANY

Copyright © 1956 by The Singer Manufacturing Company

*A Trade Mark of THE SINGER MANUFACTURING COMPANY

DESCRIPTION

Machine 147-93 is a high speed, drop feed, **one needle, one looper, two-thread** chain stitch machine, designed for sewing automobile trim, awnings, tarpaulins and similar fabrics.

The machine is adjustable to produce 3-1/2 to 18 stitches to the inch.

The machine is equipped with **independent upper and under feeds**, a stripper foot and upper and under thread nippers.

An automatic oiling system (See **Pages 8 and 9**) with a central reservoir lubricates, by splash and through tubing, all the principal bearings in the machine.

Arm rotary shaft is **counterbalanced**. This shaft is fitted with **ball bearings** for the intermediate and rear bearings adjacent to machine pulley.

Machine pulley **131914** for 3/8 inch V-belt is regularly furnished.

The machine is regularly supplied with a foot lifter. A knee lifter will be furnished instead of a foot lifter, when specified on order.

Bench Stands are furnished only at an additional charge.

Machine base is 16-1/2 inches long. Work space at right of needles is 8-1/4 inches.

When in operation, the top of the machine pulley must **always turn over away from the operator**.

Machine 147-94 for heavy stitching on auto seat assemblies, is the same as Machine 147-93, except that it is equipped with **alternating pressers** consisting of a feeding foot (that works in conjunction with a drop feed) and of a **lifting** presser foot. A **lifting** presser bar **spring**, with a more positive recoil, is furnished to insure smooth operation of pressers.

Machine 147-121 for seam covering and french felling, is similar to Machine 147-93, except that it has **two needles** and one looper, designed for **three-thread** chain stitch.

The needle gauges are 3/16 inch and 1/4 inch.

Machine 147-122 is the same as Machine 147-93, except that it has **two needles and two loopers**. This machine simultaneously produces **two rows of two-thread chain stitching**.

The needle gauges are 3/16 inch, 1/4 inch and 5/16 inch.

TO OIL THE MACHINE

Use "**TYPE B**" or "**TYPE D**" OIL, sold by Singer Sewing Machine Company. For description of these oils, see inside front cover of this book.

Automatic Oiling System:—An agitator on the lower end of the connecting rod contacts the oil in the central reservoir, at each revolution of the main shaft, lubricating various bearings **inside** the arm by splash. Pipes and wicks distribute oil to the principal bearings **outside** the arm. See large diagrams, **Fig. 10, pages 8 and 9**, showing distribution of oil.

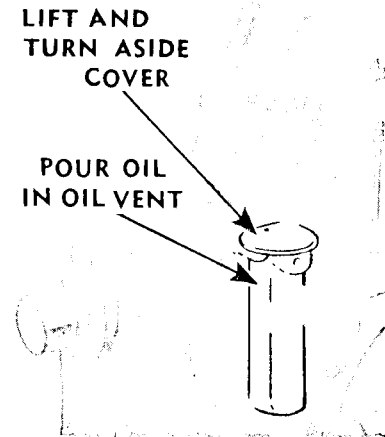

Fig. 2.
Oil Vent for Central Reservoir

To insure operation of this system and to avoid serious damage to the machine, the following instructions must be carefully observed.

A new machine, or one that has been idle for some time, must be oiled, as described on this page and on **pages 4 to 6**.

CAUTION:—The cover over the oil vent in **Fig. 2**, must be kept closed at all times, except when oiling.

Never permit oil level to drop more than 1/4 inch below level indicated in **Fig. 3**, on gauge, when the machine is at rest.

Before further oiling, remove the right hand slide plate and the face plate as instructed in **Fig. 4**. The work plate, throat plate and other parts of the machine are removed in **Figs. 5 and 6** for the purpose of illustration only.

The main oil pipe should be filled to **overflowing**, as instructed in **Fig. 5**, to aid in priming the various oil wicks.

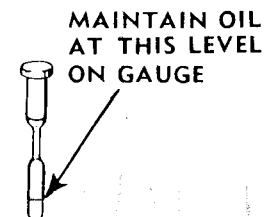

Fig. 3.
Oil Gauge

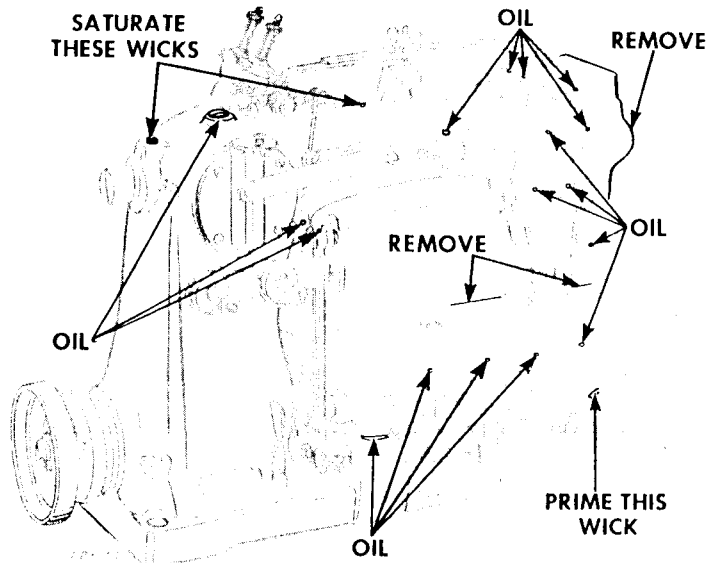

Fig. 4. Oiling Points in Rear and on Top of Machine

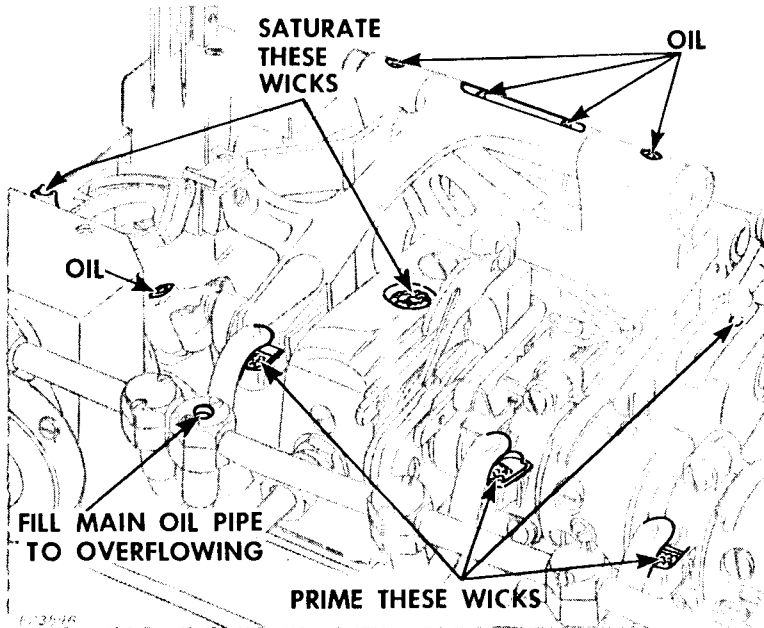

Fig. 5. Main Oil Pipe

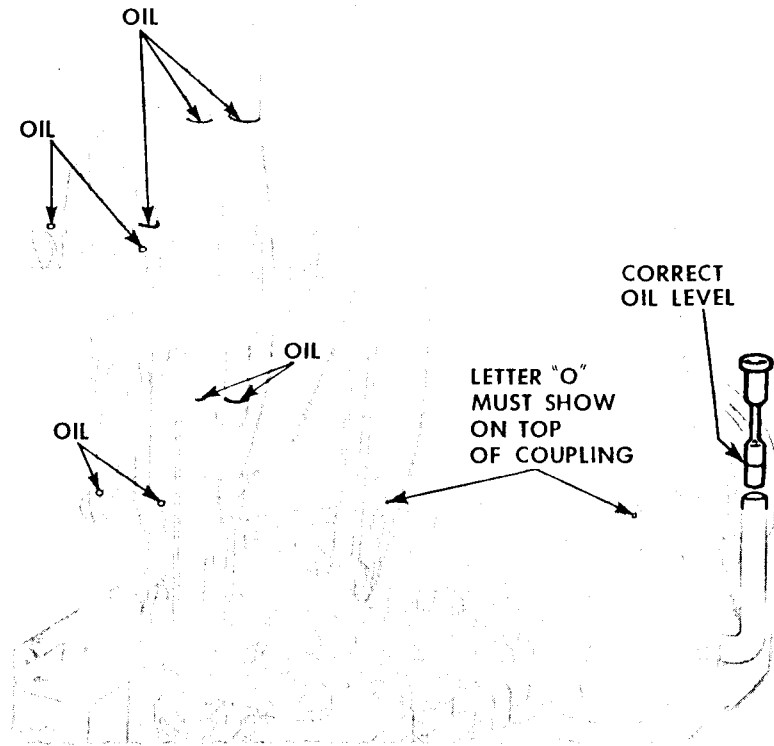

Fig. 6. Showing Position of Oil Couplings

NOTE:—The letter "o" marked on the front and rear couplings, see Fig. 6, must always be at the top, to insure that the oil spoon, attached to inner end of each coupling, is open-side up to receive oil.

IMPORTANT:—After oil has been applied to all wicks, oil holes and places where parts are in movable contact, as instructed in **Figs. 2 to 6**, run the machine at a moderate speed for five minutes. Stop the machine. Let it stand idle for a few minutes. Check oil level in reservoir. If necessary, add sufficient oil to bring it to level indicated in **Fig. 6**, on gauge.

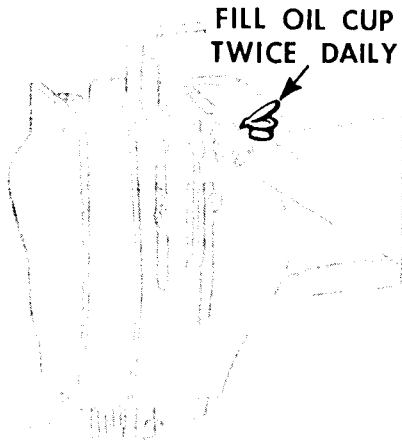

Fig. 7. Oil Cup

A machine in daily use must be oiled **twice each day**, in the following manner:

1. Apply oil to all oil holes marked "OIL."
2. Fill oil cup illustrated in **Fig. 7**.
3. Check oil level in reservoir and add oil through oil vent, when necessary, as instructed in **Figs. 2 and 3**, page 3.

SINGER Needles should be used in SINGER Machines. These Needles and their Containers are marked with the Company's Trade Mark "SIMANCO.*" 1

Needles in Containers marked "FOR SINGER MACHINES" are NOT SINGER made needles. 2

NEEDLES

Needles for these machines are of **Class and Variety 62 x 45** in Sizes 16, 17, 18, 19, 21, 22, 23 and 24.

The size of the needle to be used is determined by the size of the thread which must pass freely through the needle eye. Rough or uneven thread, or thread which passes with difficulty through the needle eye, will interfere with the proper formation of the stitch.

Orders for needles must specify the **Quantity** required, the **Size** number; also the **Class and Variety** numbers separated by letter "x."

The following is an example of an intelligible order:

"100 No. 17, 62 x 45 Needles"

Best stitching results will be obtained with the needles sold by Singer Sewing Machine Company.

TO SET THE NEEDLES

(See Figs. 8 and 9)

Turn machine pulley over away from the operator until needle bar moves up to its highest point. Loosen set screws **A**, **Figs. 8 and 9**.

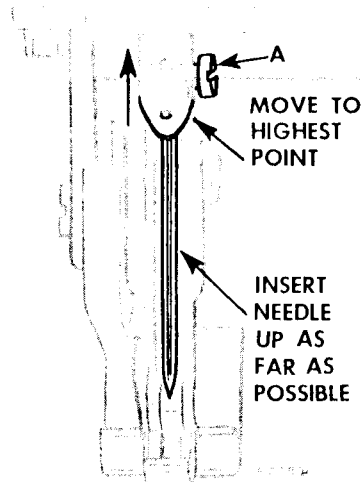

Fig. 8. Setting Needle (Single-Needle Machines)

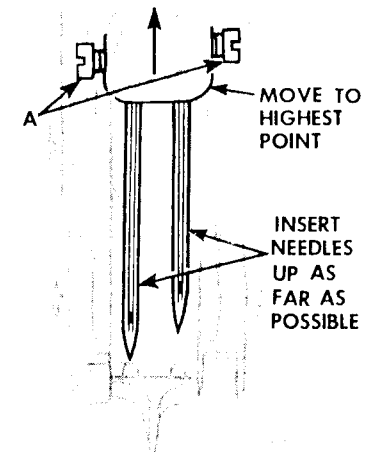

Fig. 9. Setting Needles (Twin-Needle Machines)

Insert needles as instructed in **Figs. 8 and 9**, with **single continuous groove toward the operator**. Then securely tighten the needle set screws **A**.

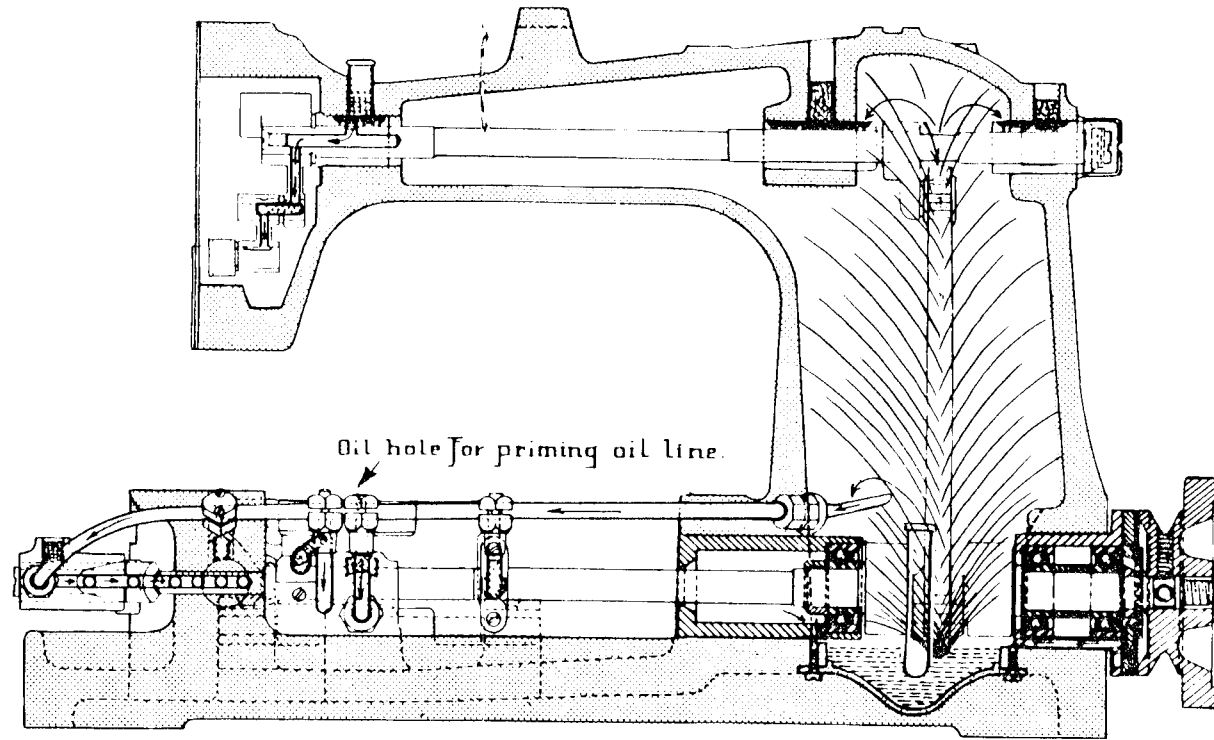
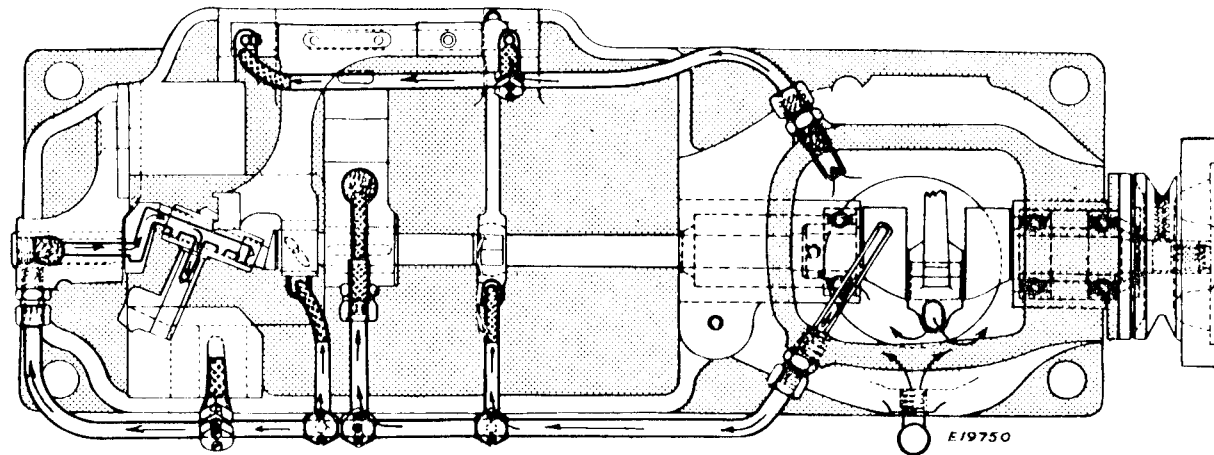

Fig. 10. Diagrams of machine showing wicks and bearings oiled by automatic splash, also bearings oiled by gravity through tubes



UPPER THREADING
Machines 147-93 and 147-94

Turn machine pulley over away from operator until **needle bar** is at its **highest** position.

Pass the thread from unwinder through threading points, in the order shown in **Figs. 11 to 13.**

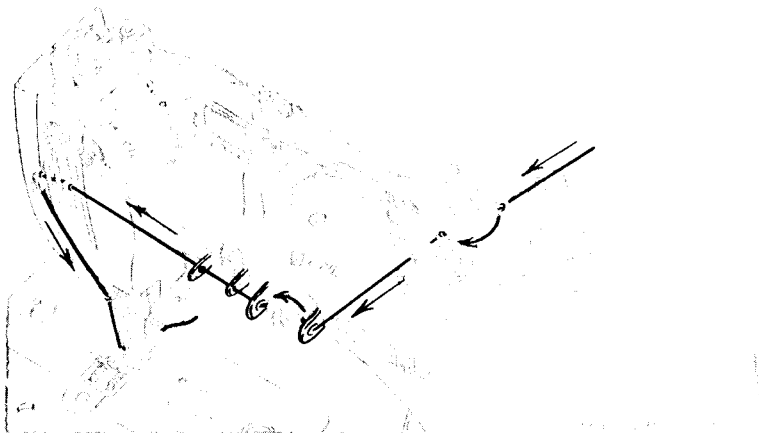

Fig. 11. Upper Threading

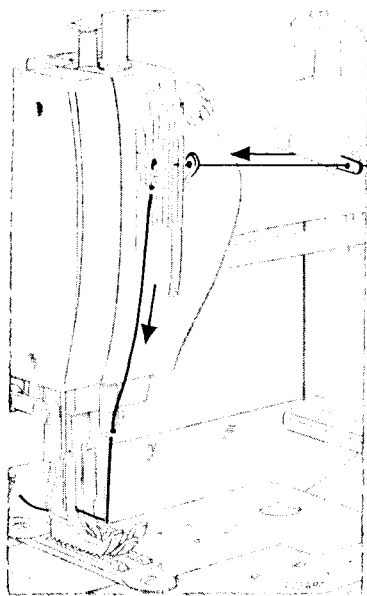

Fig. 12.
Threading Needle Thread Take-Up

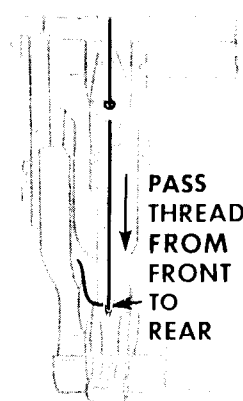

Fig. 13.
Threading the Needle

Draw about two inches of thread through the eye of the needle, with which to commence sewing.

UPPER THREADING
Machine 147-121

Turn machine pulley over away from operator until **needle bar** is at its **highest** position.

Pass each thread from unwinder through threading points, in the order shown in **Figs. 14 to 16.**

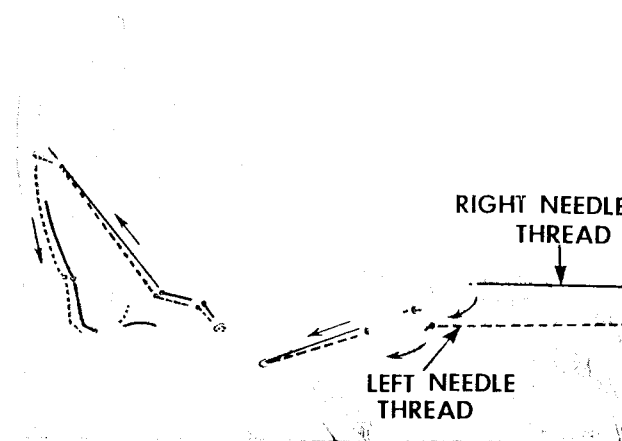

Fig. 14. Upper Threading

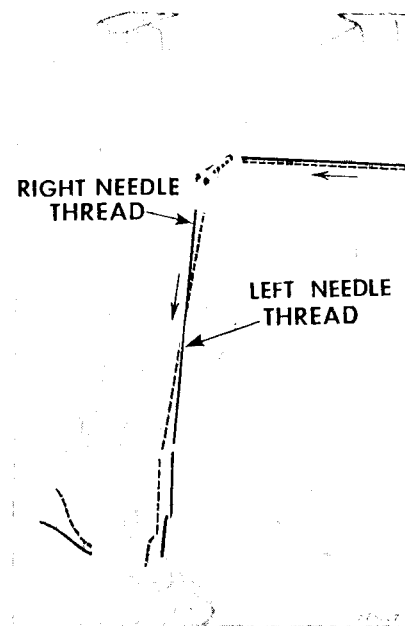

Fig. 15.
Threading Needle Thread Take-Up

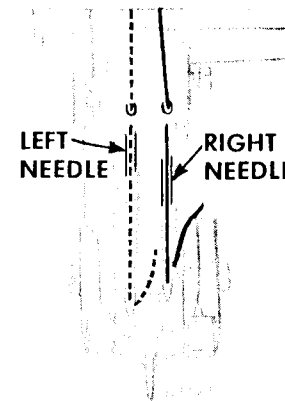

Fig. 16.
Threading the Needles

Dotted line indicates thread for **left hand** needle. Thread should pass **from front to rear**, through needle eye.

Draw about two inches of thread through eye of needle, with which to commence sewing.

TO THREAD THE LOOPERS
Machine 147-122

Remove the bed slide plate from the machine bed.
Pass each thread from the unwinder through the threading points, in the order shown in **Figs. 23 to 25**.
Dotted line indicates thread for rear looper.

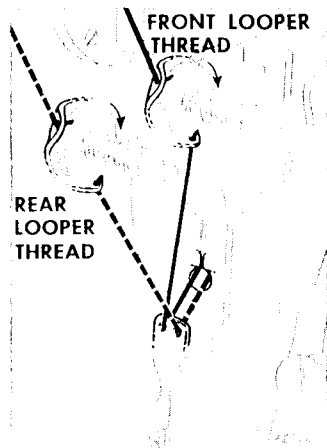

Fig. 23. Threading Looper Tension Discs

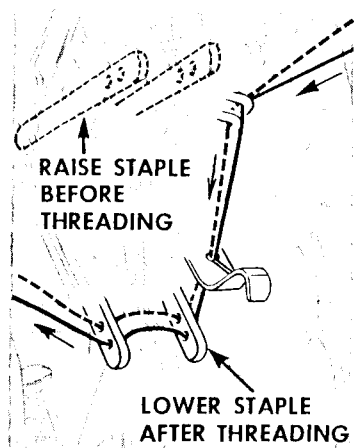

Fig. 24. Threading Looper Take-Up

Turn machine pulley over away from operator until loopers are just beginning their backward stroke. Thread heel of looper. Move loopers to end of backward stroke (**extreme right-hand position**) and thread the eye of each looper. Threaded loopers are shown in detail in circular inset at bottom left of **Fig. 25**.

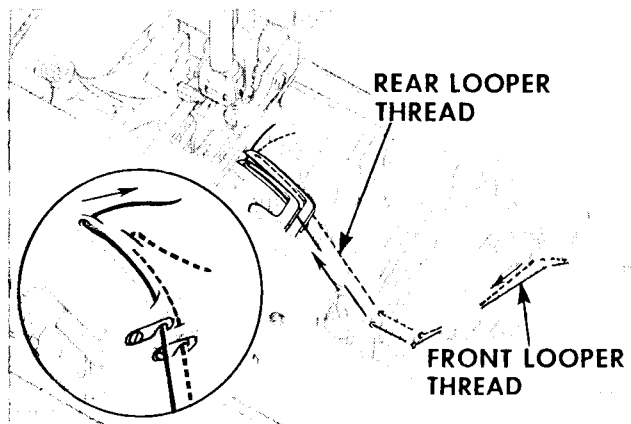

Fig. 25. Threading the Loopers

Draw about two inches of thread through eye of each looper, with which to commence sewing.

TO REGULATE THE TENSIONS

Tension on the **needle threads** should be just enough to set the stitch properly in the material.

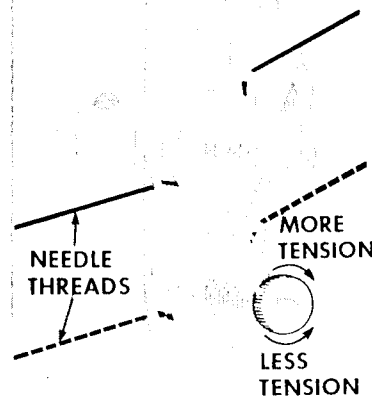

Fig. 26. Regulating Tension on Needle Threads
(View on Top of Machine)

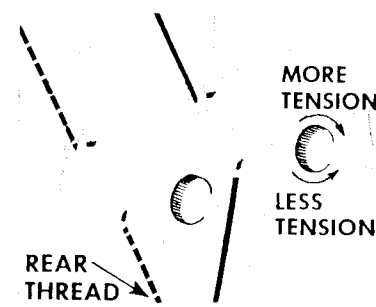

Fig. 27. Regulating Tension on Looper Threads

For average sewing, the tension on the looper threads should be very light.

TO REGULATE THE PRESSURE ON THE MATERIAL

The amount of pressure on the material should be regulated according to the type of material being sewn and the fittings in use.

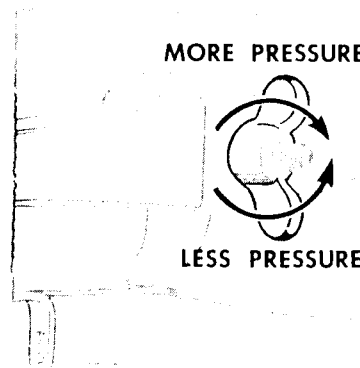

Fig. 28. Regulating Pressure on the Material
(View on top of Machines 147-93, 147-121 and 147-122)

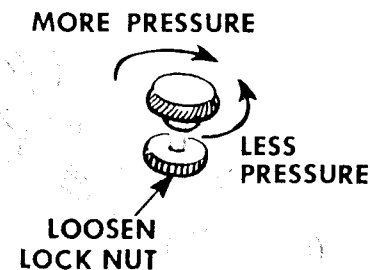

Fig. 29. Regulating Pressure on the Material
(View on top of Machine 147-94)

Always use lightest pressure possible to permit higher working speeds. There should be just enough pressure to strip the material from the needle, as the needle rises. Too great a pressure will interfere with the feeding of the material.

Machines 147-93, 147-121, and 147-122: Turn wing nut, shown in **Fig. 28**, to right or left, as required.

Machine 147-94: Loosen lock nut, as instructed in **Fig. 29**, and turn thumb screw, as required. Then retighten lock nut.

TO REGULATE THE LENGTH OF STITCH

Loosen the two set screws and turn the regulating screw, in each eccentric, as instructed in Fig. 30, below.

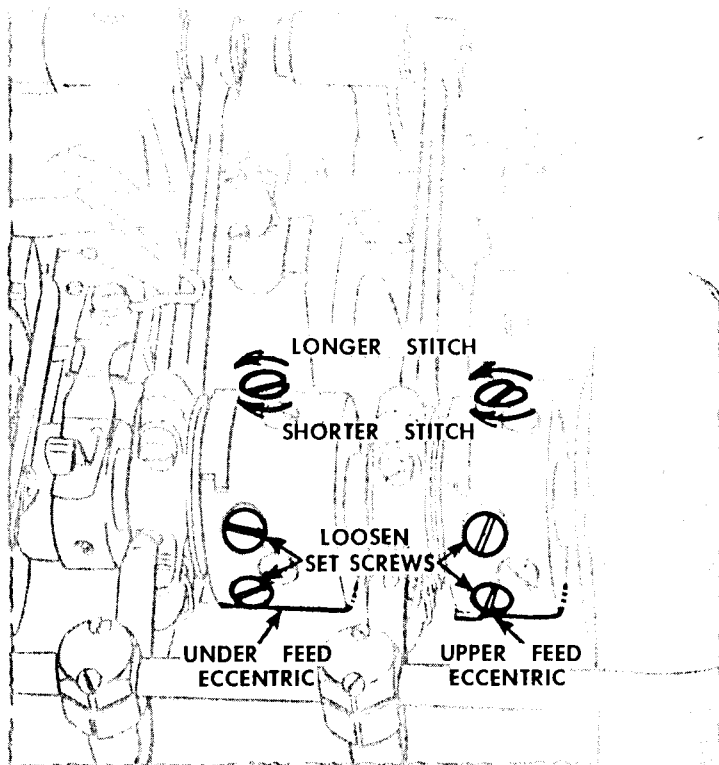

Fig. 30. Regulating the Length of Stitch

CAUTION:—If the machine is equipped with a movable needle guard, the guard should be reset.

TO ALL WHOM IT MAY CONCERN:

The improper placing or renewal of the Trade Mark "SINGER" or any other of the Trade Marks of The Singer Manufacturing Company (all of which are duly Registered Trade Marks) on any machine that has been repaired, rebuilt, reconditioned, or altered in any way whatsoever outside a SINGER factory or an authorized SINGER agency is forbidden.

SINGER Needles should be used
in SINGER Machines
These Needles and their Containers
are marked with the
Company's Trade Mark "SIMANCO.*" 1

Needles in Containers marked
"FOR SINGER MACHINES"
are NOT SINGER made needles. 2

12
UPPER THREADING
 Machine 147-122

Turn machine pulley over away from operator until **needle bar** is at its **highest** position.

Pass each thread from unwinder through threading points, in the order shown in **Figs. 17 to 19**.

Note difference in threading auxiliary take-up, as shown in **Figs. 17 and 18** for **Machine 147-122** and in **Figs. 14 and 15** for **Machine 147-121**.

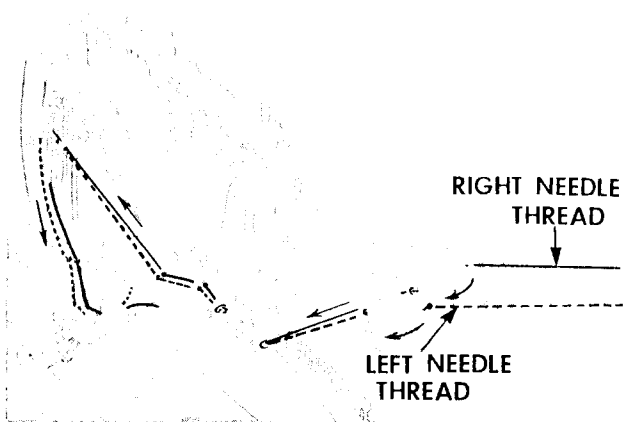

Fig. 17. Upper Threading

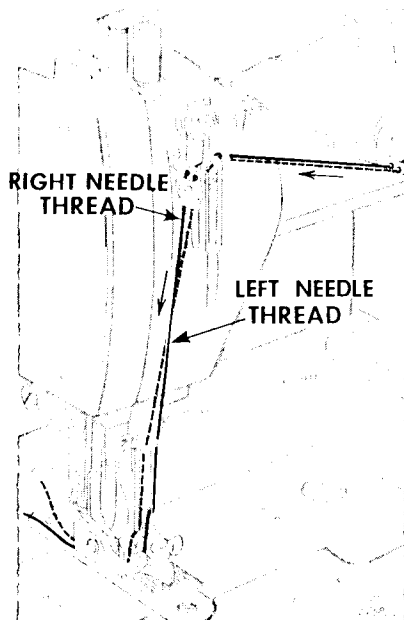

Fig. 18
 Threading Needle Thread Take-up

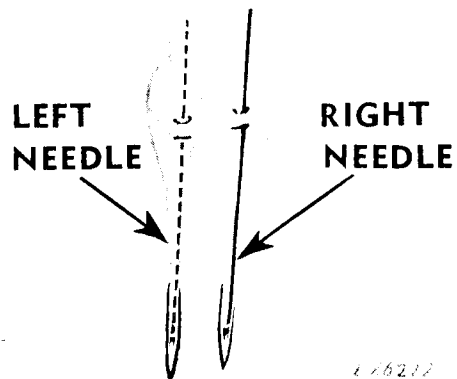

Fig. 19
 Threading the Needles

Dotted line indicates thread for **left hand** needle. Thread should pass **from front to rear**, through needle eye.

Draw about two inches of thread through the eye of each needle, with which to commence sewing.

13
TO THREAD THE LOOPER
 Machines 147-93, 147-94 and 147-121

Remove the bed slide plate from the machine bed.

Pass looper thread from the unwinder through the threading points, in order shown in **Figs. 20 to 22**.

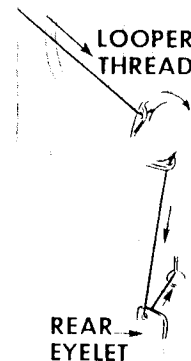

Fig. 20. Threading Looper Tension Discs

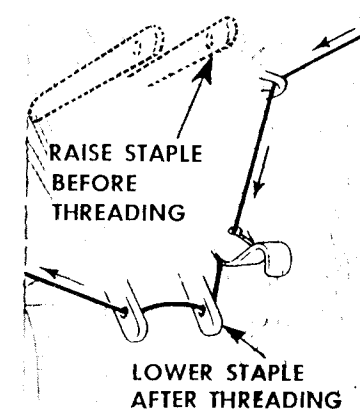

Fig. 21. Threading Looper Take-Up

Turn machine pulley over away from operator until looper is just beginning its backward stroke. Thread heel of looper. Move looper to end of backward stroke (**extreme right-hand position**) and thread the looper eye. Threaded looper is shown in detail in circular inset at top center of **Fig. 22**.

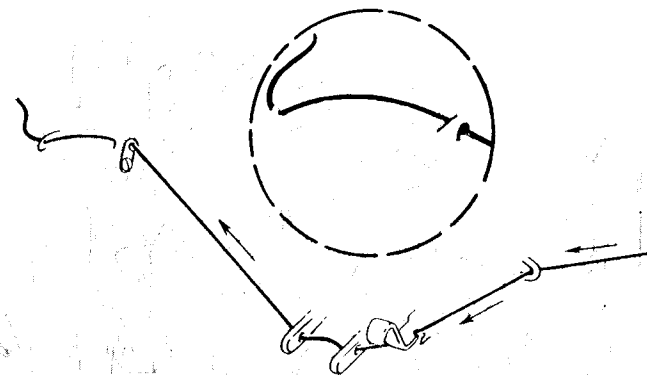

Fig. 22. Threading the Looper

Draw about two inches of thread through eye of looper, with which to commence sewing.