

Part 2: Installation Cl. 195

1. General Information	
1.1 Safety Notes	3
1.2 Machine Operation without Material	3
1.3 Table Tops	3
2. Frame Assembly	6
3. Table Top, Completing and Screwing on	7
4. Connecting the Sewing Drive to the Table Top	8
4.1 General	8
4.2 Drive Mounting	8
4.3 Voltage Compensation Motor/ Machine Head	8
4.4 Attaching the Rod and Pedal	9
4.5 Electrical connection of motors	9
5. Positioning the Machine Head, V-belt Placement, Attaching the Belt Guard and Handwheel	10
6. Making the Plug Connections to the Motor Control and Attaching the Synchronizer	11
7. Connecting the Compressed Air Maintenance Unit	12
8. Readyng the Machine for Operation	12
8.1 Fitting oil recycling device	13
9. Setting the Synchronizer	14



1. General Information

1.1 Safety Notes



Special Attention!

The mains voltage and the nominal voltage listed on the motor identification plate must be the same.

All work on the electronics is to be conducted only by authorized personnel and with the mains plug disconnected.

Please observe the safety instructions!

Installation is to be conducted according to the following instructions. All necessary parts are to be found in the enclosed package.

1.2 Machine Operation without Material



Attention!

First arrest the pressure foot in the open position and set the shortest pressure foot stroke.

1.3 Table Tops

The cutouts in self-made table tops must have the dimensions shown in the sketches on pages 4 and 5. The table tops must have the necessary load capacity and firmness.

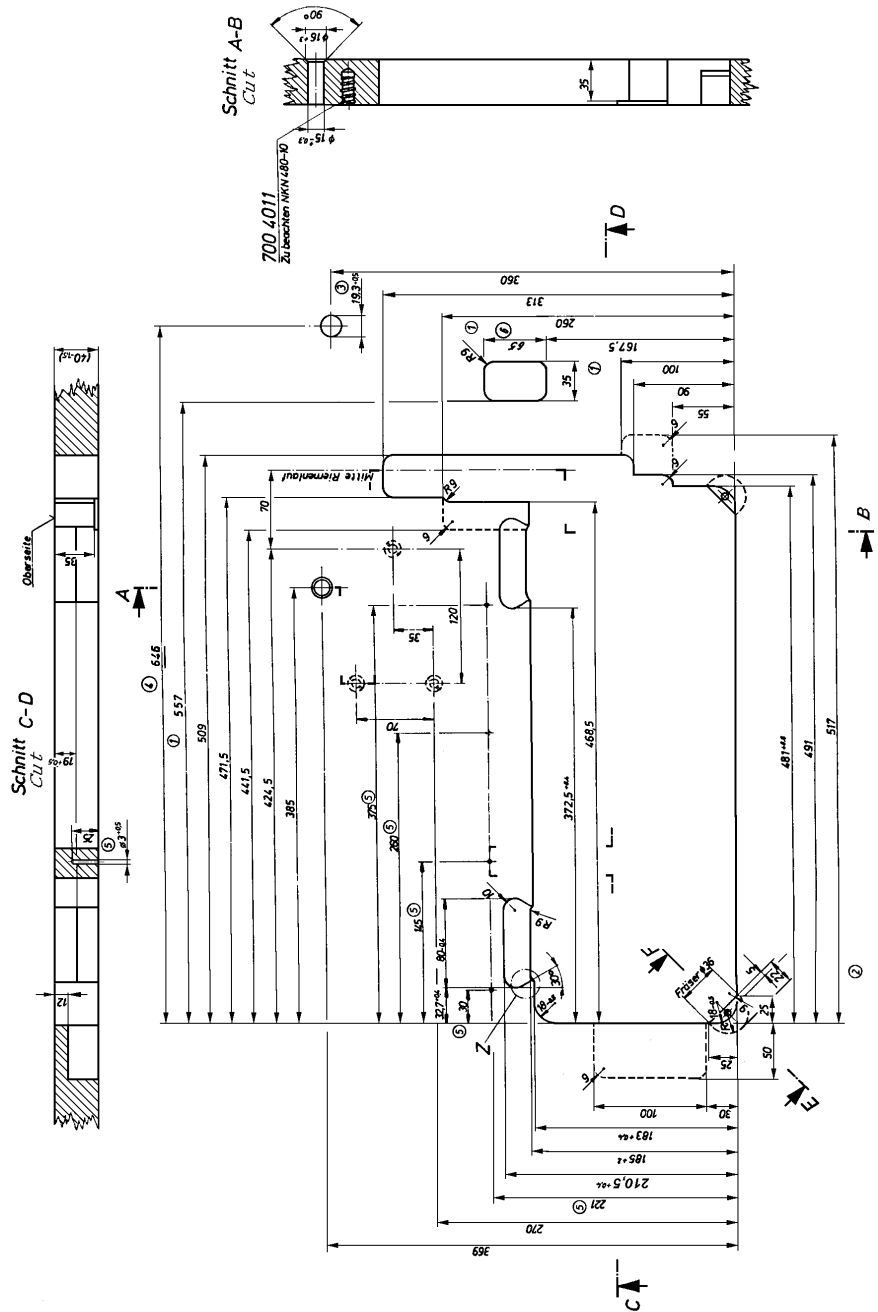



Einzelheit Z

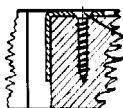
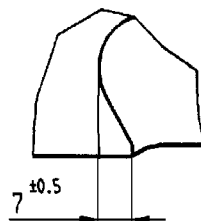
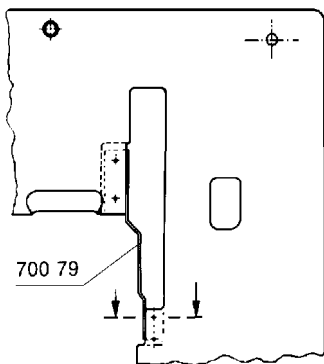

240 1023

Aspa-Spanplattenschraube 5x30 DIN 97
Aspa-Chip board screw 5x30 DIN 97

Schnitt E-F

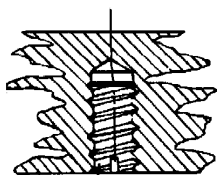
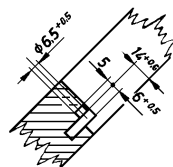

700 4011

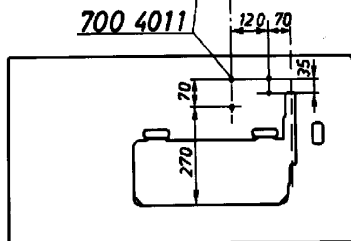

Ansicht von oben
Sight from above



2. Frame Assembly



- Mount the frame parts as illustrated.
- Align the frame with screw 1 so that all of the feet rest equally.
- Loosen screws 2 and set the table top to the correct work height.



3. Table Top, Completing and Screwing on

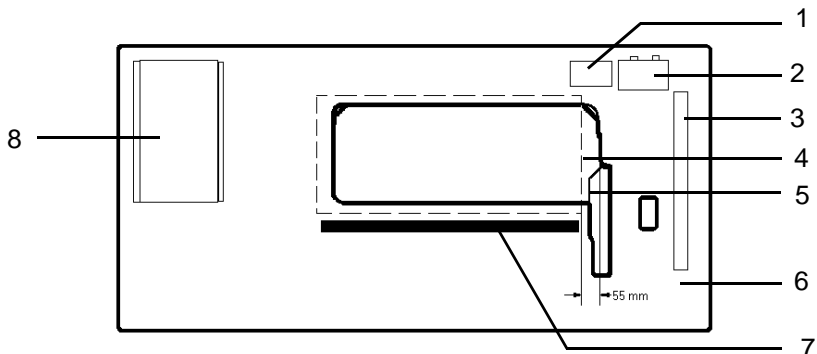

Underside of the Table Top

- Fasten the reinforcement brace 5 with 4 screws between the cutouts of the sewing head and the belt guard.
- Mount the oil baffle 4 with wood screws. Align the oil baffle so that the distance from the right side of the oil baffle to the table top cutout is 55 mm.
- Screw on the reinforcement brace 7 behind the oil baffle.
- Screw on the cable duct 3 and the holder 6 for the connection cable strain reliever.
- Screw on the main switch 2.
- Screw on the sewing light transformer 1 (if supplied).
- Screw on the drawer 8 with its mounting. Secure the insert plate against displacement with a nail.
- Screw the table top onto the frame with B8X35 wood screws.
The position of the table top relative to the frame is determined by the centering marks on the underside of the table top.

Top of the Table

- Press the rubber rests for the hinges and the forward rest points into the table top recesses.
- Press the plug into the intended hole.



4. Connecting the Sewing Drive to the Table Top.

4.1 General

Different drive and connections packages are available for the machine. The drive package consists of:

Motor, motor protection switch with wiring, belt, belt pulley.

The connections package contains all wiring between the motor and the sewing head.

The direct current drive available for this machine is operated by a "monophase alternating voltage". Therefore, with multiple machines, the connections must be uniformly distributed to the individual phases of the mains supply (3 phase). Otherwise this could lead to an overload of the individual phases.



Attention!

If the electronics are not supplied by Dürkopp Adler, then manufacture and testing is to be conducted to EN 60204-3-1/JEC 204-3-1.

4.2 Drive Mounting

- Screw the drive with its base to the table top. Hereby screw 3 M8 x 35 hex head screws with washers into the nuts in the table top.
- Fasten the V-belt pulley to the motor shaft.
- Check the arrangement of the connections on the motor terminal board and correct if necessary. The arrangement must be appropriate to the mains voltage.

4.3 Voltage Compensation Motor/ Machine Head

- Screw the connecting cable found in the enclosed package onto the motor base. It serves to conduct the static charge of the machine head to ground via the motor.



4.4 Attaching the Pedal and Rod

For ergonomic reasons the lateral direction of the pedal is to be aligned centered to the needle. Set the rod so that the pedal has an incline of 10°.

4.5 Electrical connection of motors

The required technical connecting data are listed in the circuit diagram enclosed in the drive package.



5. Positioning the Machine Head, V-belt Placement, Attaching the Belt Guard and Handwheel

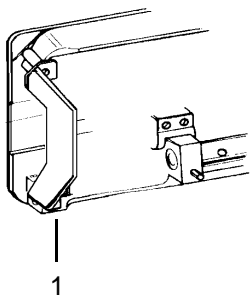
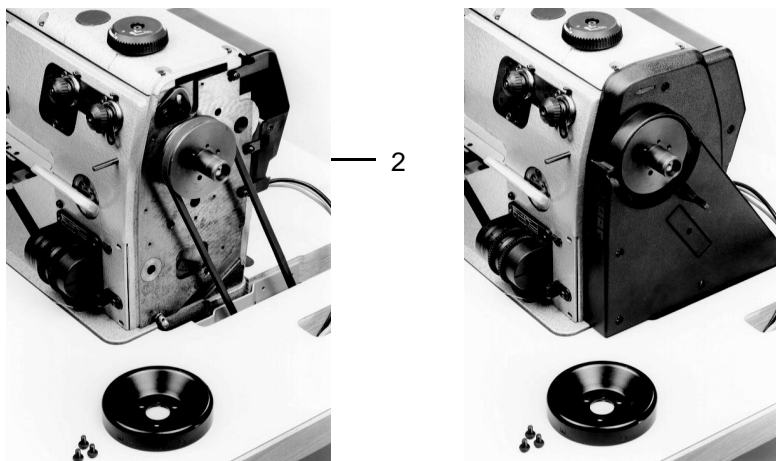

- Set the sewing head into the table top cutout.
- Fold over the sewing head and remove the safety bar 1.
- Plug the arresting pin 2 into one of the notches of the built-in adjustment disc.
- Screw off the handwheel.
- First place the V-belt over the machine belt pulley.
- Place the belt on the motor belt pulley. By swinging the motor tension the V-belt so that it can be pressed in at its center by about 10 mm without great effort.
- Screw on the belt guard with 5 screws. When folding over, the belt guard must go into the table top cutout unimpaired.
- Screw on the motor belt guard. Set the securing cams so that the belt does not slip out of the belt pulley when the sewing head is folded over.
- Screw on the handwheel. The correct position of the handwheel is derived from the additional holes in the hand wheel and on the belt flange. They must lie congruent.



6. Making the Plug Connections to the Motor Control, Attaching the Synchronizer (Only Positioning Drive)

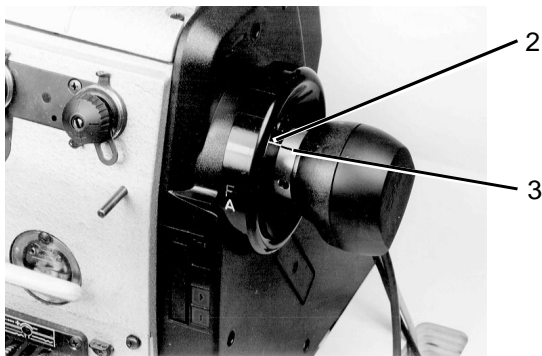
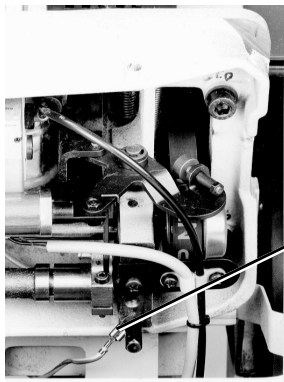

- Fold over the machine
- Connect the voltage compensation lead **1** to the head.
- If supplied, connect the external control panel.
- Lay the wiring for buttons, control panel and, if supplied, sewing light in the head cable duct.



Attention!

Before installing the synchronizer, switch off the thread trimmer function on the control panel.

- With the machine switched off, push the synchronizer onto the handwheel so that its groove catches over the mounting pin on the belt guard.
- Arrest the handwheel in position **A**.
- Screw on the synchronizer.
Position the marking **2** directly opposite the notch **3**.
This is position "0", the dependent initial position for all machine position settings made at the factory.
For setting the 1st and 2nd needle positions see Section 9.



7. Connecting the Compressed Air Maintenance Unit

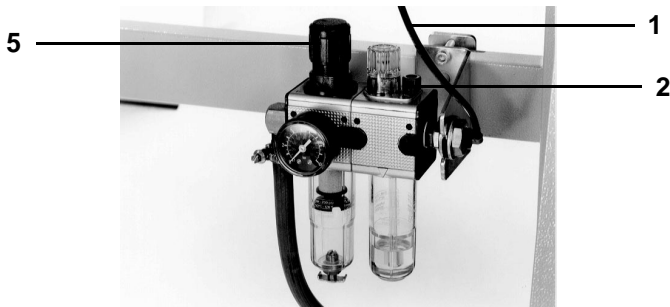

For operation of the pressure foot stroke, stitch condensation and thread trimming, a supply of water-free, lightly oiled compressed air is required.

- Screw the maintenance unit to the frame.
- Establish the PU3-hose connection 1 between the maintenance unit and the machine head.
- With the compressed air **disconnected** or shut off, fill lubricating oil ESSO SP-NK 10. Open screw 2 and fill up to the grooved marking.
- Connect the maintenance unit connector hose to the compressed air supply.
- Pull up the handle 5 and set an operating pressure of 6 bar by turning.

8. Readyng the Machine for Operation

- Mounting the Yarn Stand
- Fill the oil tank for the central oil wick lubrication up to the upper marking line (see Operating Instructions Section 2.1)
- Plug in the mains plug.
- Briefly switch on the motor protection switch for three phase motors. Check the direction of rotation on the motor ventilation wheel. See arrow on the belt guard. If the direction of rotation is incorrect interchange 2 phases in the mains plug.
- Check the feed quantity of the oil mister (approx. 1 drop every 10 work cycles). Correct if necessary. See Section in the Operating Instructions.



5.1 Fitting oil recycling device

The oil recycling device collects the oil in the oil sump and returns it by a pump to the oil circuit.

- Wrap intake filter 3 of the oil recycling device by the felt and fasten it to the oil sheet by the clamp 2.
- Install the oil hose 1 and secure it so that it cannot get into contact with mobile parts.

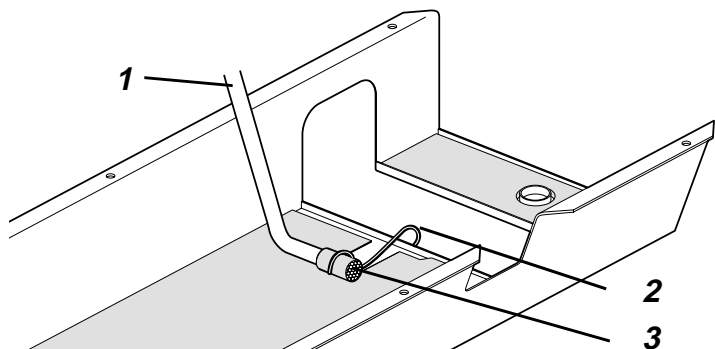

ATTENTION !

Change the oil every 2 years, irrespective of the number of operating hours.

9. Setting the Synchronizer

The machine positions are seen by the synchronizer in steps (increments) of 0.7° and shown in the display. A complete revolution corresponds to 512 steps.

1st Position

The machine should stop when the hook has securely taken up the loop.

This means that the needle should raise above its lower dead center until the hook tip has moved approx. 6 mm above the needle to the left. This corresponds to the increment number 50.

2nd Position

Needle bar a little bit before the upper dead center. This corresponds to the increment number 190.



Programming the Positions:



1. Hold key P pressed.
2. Switch on the main switch. Code-No. C 0000 appears in the display.
3. For entry to the " Technician Level 1"
enter Efka Code-No. 1907 with the keys 1 ...0.
4. Press key E. Parameter- No. F100 appears in the display.
5. Enter parameter-no. F170 with the keys 1 ...0.
Press key E. Service-Routine 1 (Sr1) appears.
Press key F. Position 0 appears.
6. Turn the handwheel one full revolution in the machine direction and
arrest in position A with the enclosed arresting pin.
Press key P twice.
7. Press key P drücken. F170 appears in the display.
8. Press key E twice. Service-Routine 2 (Sr2) and F171
appear in the display.
9. Press key F. Position 1 and the set increment number
appear in the display.
Using keys + or - set the increment number 50.
10. Press key E. Position 2 and the set increment number
appear in the display.
Using keys + or - set the increment number 190.
11. Press key E. Position 1A and the set increment
number appear in the display.
Using keys + or - set the increment number 100.
12. Press key E. Position 2A and the set increment
number appear in the display.
Using keys + or - set the increment number 240.
13. Press key P twice. This completes the setting.
14. **Attention!**

It is essential that a seam be sewn with thread trimming and raising the pressure foot. This is the only way for a setting to be definitely stored in the memory. Without sewing the setting is lost when the machine is next turned off.